



**Advanced Simulation Technology inc.**  
500A Huntmar Park Drive  
Herndon, Virginia 20170 U.S.A.  
Tel. (703)471-2104 • Fax. (703)471-2108  
[www.asti-usa.com](http://www.asti-usa.com)



## **Workstation Operator Manual**

**Document: DOC-01-SYNW-OM-1**



Product Name: ASTi Synapse Workstation

Description: Network Voice Communications System

Part No.:

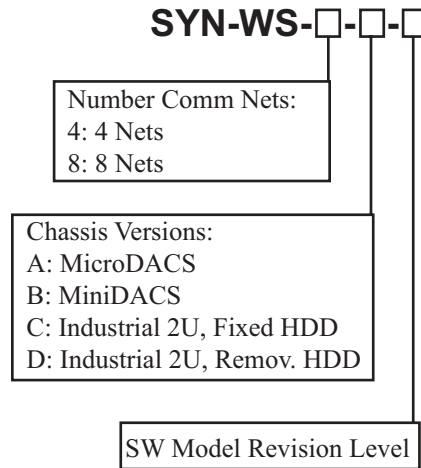

ASTi Synapse Workstation Operator Manual

© Copyright ASTi 2000-2006.

Restricted Rights: Use, duplication, or disclosure by the Government is subject to restrictions as set forth in subparagraph (c)(1)(ii) of the Rights in Technical Data and Computer Software clause at DFARS 252.227-7013.

This material may be reproduced by or for the U.S. Government pursuant to the copyright license under the clause at DFARS 252.227-7013 (1994).

ASTi

500A Huntmar Park Drive

Herndon, VA 20170



# TABLE OF CONTENTS

<b>1. TABLE OF CONTENTS</b> .....	<b>1</b>
<b>2. GETTING STARTED</b> .....	<b>1</b>
Overview of Features .....	1
Operational Overview .....	1
<b>3. FUNCTIONAL DESCRIPTION</b> .....	<b>3</b>
2A. Synapse RT-Network Bridge .....	4
<b>4. SUMMARY OF OPERATION</b> .....	<b>5</b>
<b>5. SYSTEM CONFIGURATION</b> .....	<b>8</b>
4A. Standard Hardware Configuration .....	8
4B. Ancillary Device Options .....	9
4C. Software Configuration .....	10
<b>6. ASTi HARDWARE INSTALLATION</b> .....	<b>11</b>
5A. RIU Configuration .....	11
5B. TDM Ring Installation .....	12
5C. Operator Station Installation .....	13
5D. Main Node Installation .....	15
<b>7. INTEROPERATION WITH LIVE RTs</b> .....	<b>16</b>
<b>8. SYSTEM CONFIGURATION SOFTWARE</b> .....	<b>17</b>
7A. DIS Network Configuration .....	19
7B. Voice Compression Configuration .....	21
<b>9. SYSTEM INITIALIZATION SOFTWARE</b> .....	<b>22</b>
8A. Initialization of Operator HHT Settings, DIS Frequency and DIS Exercise ID .....	24
<b>10. SYSTEM STARTUP and SHUTDOWN</b> .....	<b>27</b>
<b>11. PRE-OPERATIONAL SYSTEM CHECKOUT</b> .....	<b>28</b>
10A. Error Check .....	29
10B. TDM Card and RIU Check .....	30
10C. Software Status .....	32
10D. Handheld Terminal Check .....	33
10E. DIS Network Check .....	34
<b>12. LIVE RT INTERCOMMUNICATIONS</b> .....	<b>39</b>
<b>13. OPERATOR STATION CONCEPTS</b> .....	<b>40</b>
12A. Operator Station Operation .....	42
<b>14. ADVANCED MAINTENANCE TOOLS</b> .....	<b>48</b>
<b>15. SYSTEM TROUBLESHOOTING</b> .....	<b>55</b>
14A. Main Node Troubleshooting / Error Messages .....	56
14B. TDM and RIU Troubleshooting .....	59
14C. Operator HHT Troubleshooting .....	61
14D. Operator Station Troubleshooting .....	63
14E. Base RT Troubleshooting .....	64
14F. DIS Network Troubleshooting .....	65
<b>APPENDIX A: RIU v4.1 TECHNICAL GUIDE</b> .....	<b>66</b>
<b>APPENDIX B: COLD START</b> .....	<b>69</b>
<b>APPENDIX C: SAFETY and HANDLING</b> .....	<b>70</b>
<b>APPENDIX D: WARRANTY and CUSTOMER SUPPORT</b> .....	<b>71</b>
<b>APPENDIX E: RMA PROCEDURE</b> .....	<b>72</b>
<b>APPENDIX F: FURTHER READING</b> .....	<b>73</b>



# 1. GETTING STARTED

## Overview of Features

ASTi's Synapse Workstation is a digital communications system that is used to link operator voice traffic between distributed sites over local or wide area data networks. The Synapse Workstation is a specialized and pre-configured application of ASTi's Digital Audio Communications (DACS) product line. It is a completely self-contained product, including everything you need to establish a sophisticated network-based voice communications system: ASTi digital signal processing and network communications software suite, hand-held terminal operator interfaces, headsets, microphones and audio cables.

Synapse Workstation is a highly scalable system. You can connect up to eight operators to a single Synapse Workstation node. If your application requires more than local eight operators or distribution to widely dispersed operator positions, simply connect more Synapse Workstations to the network. This network-centric architecture means that an elegant wiring scheme is implemented. Synapse Workstation nodes on the network are connected by standard ethernet cables. Operators can be located wherever there is access to the network.

In addition to operating as a network-based intercom system, the Synapse Workstation is interoperable with ASTi's Synapse Radio Transceiver (RT) to Network Bridge system. The Synapse RT Bridge links live radios to the data network, allowing you to literally plug live radios into your simulation network. This realizes many powerful capabilities:

- Radio-repeating between distant sites, using your data network ("Radio Over IP")
- Linking live radios to Synapse Workstation operators via virtual networks
- Live-radio and Synapse Workstation voice traffic can be logged for after-action-review

## Operational Overview

Each Synapse Workstation operator interface includes a hand-held terminal user control and display device. A wide variety of optional operator peripherals are available: headsets, PTTs, paging mic with PTT, powered speaker, industrial headsets, etc.

The system is completely plug-and-play. To install the system, simply: interconnect components using standard network cables, plug in headsets and hand-held terminals.

The system is pre-configured through software script files prior to startup. Using simple commands, the user can preset all system level parameters, like: network IP addresses and digital voice compression schemes. Operator level parameters are also set, including: operator communications assignments for net transmission and reception. System configuration is accomplished in minutes, without changes to the hardware installation.

A complete system description of Synapse Workstation can be found in Chapters 2 through 4. A brief summary of Synapse RT Bridge is found in Chapter 2.

We have not included a "Quick Start" chapter because such a superficial approach would deprive users of the critical understanding necessary to install, operate and maintain the system. We highly recommend that first-time users read the complete installation, operation and maintenance information presented in Chapters 5 through 14.

To help users who are familiar with the system, here is a guide to finding necessary setup and integration information:

**Chapter 5A:** Setting the internal jumpers and address switch on each of the Remote Interface Units (RIUs).

**Chapter 5B:** Installing the RIUs on the Time Division Multiplex (TDM) ring and connecting to the TDM card in the Synapse node.

**Chapter 5C:** Connecting the operator audio and hand held terminal (HHT) equipment to the RIUs.

**Chapter 5D:** Main Synapse Workstation node installation.

**Chapter 6:** Connecting to the Synapse Radio-Network Bridge.

**Chapter 7A:** Configuring DIS network parameters using the DEFAULT.CFG file.

**Chapter 7B:** Configuring voice compression using the DEFAULT.CFG file.

**Chapter 8A:** Setting the initial system startup parameters for the operator HHTs and the DIS Exercise ID using the SYN.INI file.

**Chapter 9:** Starting and shutting down the system.

**Chapter 10:** Performing pre-operational verification tests:

**Chapter 10A:** Error Checks

**Chapter 10B:** TDM Ring & RIU Check

**Chapter 10C:** Software Load Status

**Chapter 10D:** HHT Check

**Chapter 10E:** DIS Network Check

**Chapter 11:** Inter-operating with Synapse-bridged RTs

**Chapter 12:** Operator Station: the basics

**Chapter 12A:** Operating the HHT and optional PTTs

**Chapter 13:** A guide to the advanced maintenance tools.

**Chapter 14:** Troubleshooting

**Chapter 14A:** Main Node and Error Messages

**Chapter 14B:** TDM Ring and RIUs

**Chapter 14C:** HHT

**Chapter 14D:** Operator Station Communications

**Chapter 14E:** RT Interoperation

**Chapter 14F:** DIS Network

## 2. FUNCTIONAL DESCRIPTION

ASTi's Synapse Workstation system is a powerful voice communications system that realizes voice communications using local and wide area IP networks. Following is an overview of Synapse operation. Refer to Figure 1:

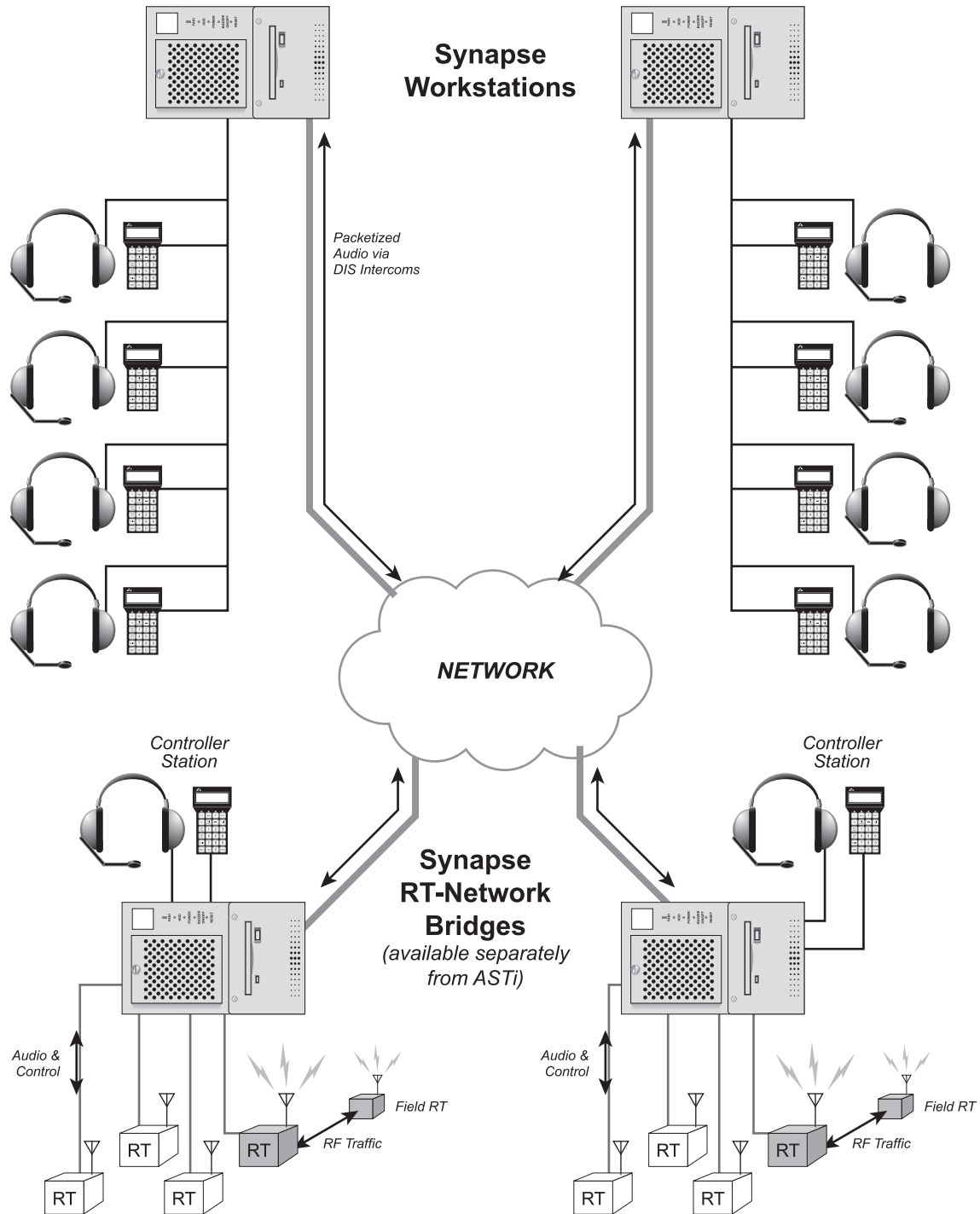

Figure 1: Synapse Workstation operating with Synapse RT- Network Bridge, Top Level View

- A.** Each Synapse Workstation node features operator interfaces that provide direct connection points for mic and speaker audio lines. For voice transmission, analog audio from an operator's microphone is passed to the Synapse system for digitization, compression and packetization. Each voice stream is associated with a DIS intercom, which is assigned a specific, virtual frequency.
- B.** The Synapse Workstation node transfers the DIS intercom voice packets to other operators connected to the local node or to other remote Synapse nodes residing on the network. Note that there may be any number of Synapse Workstation nodes residing on the network and each node can be configured to receive and process digitized voice transmissions.
- C.** On a remote Synapse Workstation node, a DIS intercom–tuned to a matching frequency–receives, de-compresses and decodes the data packets producing an analog audio stream.
- D.** ASTi's digital signal processor (DSP) running inside the Synapse Workstation node distributes the voice stream to specific operators connected to the local or remote Synapse Workstation nodes.
- E.** Each of the DIS intercoms can be thought of as a virtual communications net that extends across the data network, linking all operators that share a specific intercom frequency.
- F.** For the sake of clarity only one communication net is described, however each Synapse Workstation system can simultaneously process many independent nets.

## **2A. Synapse RT-Network Bridge**

ASTi's Synapse Radio to Data Network Bridge (Synapse RT Bridge) is a digital voice communications system that links tactical radio transceiver (RT) traffic between various sites over local and wide area data networks. It basically functions as a re-transmitter, using IP voice network technology in place of traditional radio frequency links.

In summary, here's how the Synapse RT Bridge works:

Base station RTs receive audio over-the-air from field RTs. Analog audio streams from the base station RTs are interfaced to a DSP-based Synapse node, which digitize and attach the audio streams to discrete DIS intercoms. DIS communications are transported over IP networks, then received by other Synapse nodes. These remote Synapse nodes re-generate the analog audio streams and pass them to base station RTs for over-the-air transmission into the field.

Synapse RT Bridge can also establish links between live RT traffic and human operators located at network-based ASTi Synapse Workstations, because the virtual DIS nets extend transparently across the IP network to any ASTi node.

Contact ASTi for more information about the Synapse RT Bridge.

### 3. SUMMARY OF OPERATION

Refer to Figure 2 for a node level view of the Synapse system:

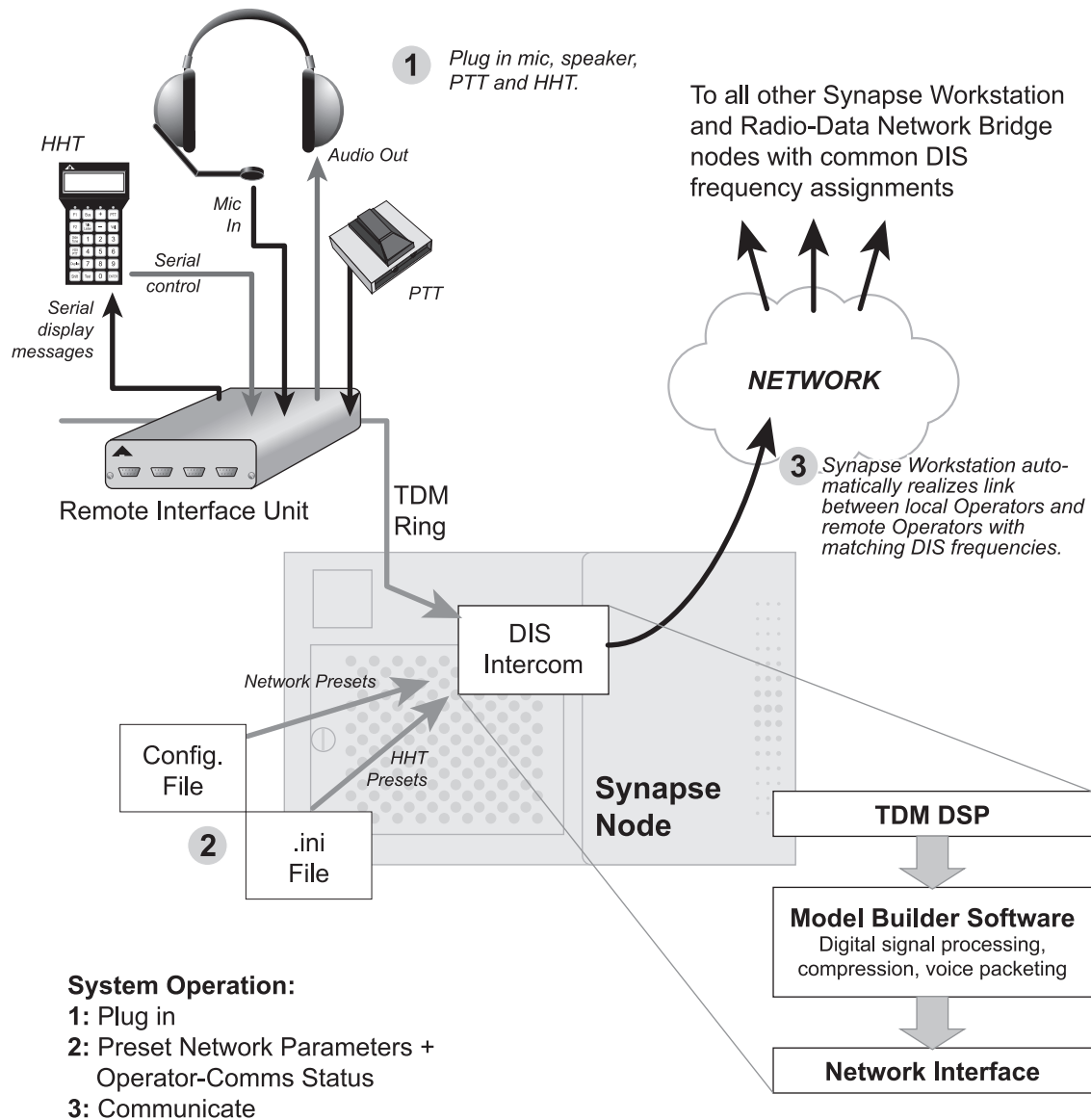

Figure 2: Synapse Workstation, Node Level View

**A.** At the heart of the Synapse Workstation system is an ASTi base node (Digital Audio Communications System or DACS) that includes key digital signal processing hardware and software to implement the operator to network interface. Synapse Workstation is an embedded system - it operates automatically once configured by the user.

**B.** DSP processing modules called Remote Interface Units or RIUs, establish the operator interfaces to the node, including: analog audio signal lines (microphone and speaker or headset), discrete digital controls (push-to-talk or PTTs) and serial controls (from the hand held terminals or HHTs).

**1.** RIUs contain both signal conditioning circuitry as well as A/D and D/A circuits for conversion of audio between the analog (operator interfaces) and digital (networked Synapse) domains.

**2.** RIU Analog and Control interfaces include:

**a.** Audio Input: An analog interface that digitizes operator microphone audio, then routes it to the Synapse system, where it is encoded and packetized for transport to other local node operators or over the IP network to remote Synapse systems.

**b.** Audio Output: An analog audio interface that receives and routes digital audio signals, originating from either local or remote operator transmissions, to specific operator interfaces, where the signals are converted to analog format and amplified for distribution to headsets or speakers.

**c.** Digital (PTT) Input: A discrete digital control interface that senses switch states (open or closed) from operator PTTs. PTT signals are routed to the DACS node, where they are used to key operator network transmissions.

**d.** Serial Data: the serial data interface connects the operator HHT to the RIU and the Synapse node running the communications software model. This full-duplex interface provides: transmission of control data from the HHT buttons (volume, PTT, receive and transmit net selection) to the Synapse communications model and reception of display data (communications status messages) from the communications model.

**3.** The RIU digital interface to the main DACS node is a Time Division Multiplex (TDM) ring. To create the TDM ring, RIUs are cabled together in a daisy chain fashion using standard Category 5 network cable, then both ends of the ring are cabled to a TDM Controller card located in the main DACS node.

**a.** Audio and control signals processed by RIUs are distributed on the TDM ring back to the TDM Controller card in the DACS node for processing by ASTi's DIS communications software.

**b.** Voice signals generated by the TDM controller card in the DACS node are transported over the TDM ring to the RIUs, where they are converted to analog format and routed to the correct channels.

**c.** Digital audio and control signal distribution realized by ASTi's TDM architecture provides the benefits of: tidy cable runs and immunity to electrical noise pickup and cross talk.

**C.** Distributed Interactive Simulation (DIS) Networking. The Synapse Workstation node includes embedded DIS communications software to provide the IP network transport mechanism for operator voice traffic.

**1.** ASTi's embedded software application, called Model Builder, runs inside the main Synapse Workstation node, executing a specialized software program called the custom model.

**2.** The custom model configures a series of DIS network intercoms. The software model associates DIS intercoms with operators connected to specific RIU interfaces.

**3.** The Synapse system user presets and stores the frequency values of each DIS intercom using a simple script file. The system is very flexible - each operator can be assigned access to any of the 16 available DIS intercoms. (Remember that these same DIS intercoms can be linked to live RTs using the Synapse RT Bridge, giving Workstation operators the same communication capabilities as operators using a live RT.)

**4.** The system also includes software utilities that provide network-wide coordination, monitoring and debugging.

**5.** ASTi can also provide High Level Architecture (HLA) voice networking solutions. For more information about ASTi's HLA products send us a message at [info@asti-usa.com](mailto:info@asti-usa.com).

**6.** Multiple voice compression algorithms are provided so that the user can optimize the system for maximum voice quality (with higher bandwidth consumption) or minimum bandwidth consumption (with slightly degraded voice quality).

**7.** System-level presets are user defined through a script file that is automatically loaded upon system startup. The file stores commands that preset DIS system level parameters such as: network IP addresses and port numbers, DIS site and host IDs and voice compression types.

**D. Operator Ancillaries.** The standard operator station includes an ASTi Handheld Terminal (HHT) communications user interface device.

**1.** Optional audio peripherals are available, including: headsets, desk mic and speaker, foot-switch PTT and belt clip PTT with volume).

**E. Configurations and Scalability:**

**1.** Each Synapse Workstation node is available in two basic versions: Four Operator and Eight Operator.

**2.** The system is highly scalable. Simply connect additional Synapse Workstation nodes to the network to add more operators to your local site or to add more sites.

**F.** Note that the Synapse system does not provide built-in data network encryption. To establish a secure end-to-end network, the user should install NSA Type I data encryption devices (KG-84, KIV-7, etc.) at IP network connection points.

## 4. SYSTEM CONFIGURATION

### 4A. Standard Hardware Configuration

A. The standard Synapse Workstation includes the following components:

DESCRIPTION	ASTi PART NUMBER	QTY for SYN-WS-04 (4 Ops)	QTY for SYN-WS-08 (8 Ops)	STANDARD FEATURE?
Main Node: Digital Audio Communications System (DACS), includes: Intel processor, CompactFlash drive (version -BB), fixed HDD (version -CB), removable HDD (version -DB), diskette, Time Division Multiplex (TDM) DSP, 100BaseT ethernet. ASTi software configuration is described in Chapter 4D.	-BB Version: ND-MN-TA1-F1-CF  -CB Version: ND-2U-TA1-F1-FD  -DB Version: ND-2U-TA1-F1-RD	1	1	-BB: Yes. -CB: Optional. -DB: Optional.  Keyboard and monitor are customer-furnished.
Remote Interface Unit, 4 Channel	SYN-RIU-OP (Marked "Operator RIU")	2	4	Yes.
TDM Ring Cable, interconnects RIUs. Category 5, UTP, straight-through wiring.	CA-RJ45-RJ45-L L = Length in ft.	3	5	No. Customer-furnished or ordered separately.
Handheld Terminal User control and display: net transmit/receive, volume, PTT.	HHT-01-RAD	4	8	Yes. Also includes 7 ft. coiled cable, ASTi PN: CA-RJ12-RJ12-7-A
Operator audio and PTT ancillaries (headset, desk mic, PTTs, speakers, cables)	various	4 sets	8 sets	Optional. See Chapter 4C for other audio and control options.

## 4B. Ancillary Device Options

ASTi offers wide variety of optional ancillary devices, including:

OPTION DESCRIPTION	ASTi PART NUMBER	REQUIRES ASTi CABLE
Lightweight headset with noise-canceling mic	HS-TX-PH88R	Headset to RIU, 6 ft. CA-D9M-X4F-6-B
Industrial/hearing protector headset with noise-cancelling mic. For use in high noise environments.	HS-TX-PH10R	Headset to RIU, 6 ft. CA-D9M-X4F-6-B
PTT box with volume and belt clip. Connects inline with lightweight or industrial headset.	PTT-01-002	PTT box to RIU, 6 ft. CA-D9M-X6F-6-B
Amplified speaker with volume control. Rugged all-metal/magnetic shielded case and grill.	A-PS	Speaker to RIU, 6 ft. CA-D9M-X3M-6-A
Desktop mic with built-in PTT switch.	A-MIC-01	None. Cable fixed to mic.

1. There are four operator interfaces (for audio and discrete PTT) available on each RIU.
2. The configuration of auxiliary audio and PTT devices is completely flexible. You can plug any of the devices into any of the operator RIU interfaces.
3. All of the listed devices consume one of the four available operator RIU interfaces.
4. A physical configuration diagram is shown in Figure 4.
5. Contact ASTi if you need advice about operator station ancillaries.

## 4C. Software Configuration

**A.** The following software modules are integrated into the Synapse Workstation.

**B. *IMPORTANT:*** The DEFAULT.CFG and SYN.INI files are the only user-alterable files on the system. Do not alter any other system files or you may disable system operation, requiring the re-loading of system files, or even a full cold start procedure.

DESCRIPTION	DIRECTORY \ FILENAME	VERSION	USER CONFIGURABLE?
MODEL BUILDER: Application software, communications toolkit	C:\[VARIABLES] C:\MBUILDER[VARIABLES] C:\MBUILDER\BIN[VARIABLES]	4.09d or higher	No.
OPTIONS FILE: This customer-specific software protection keycode file is unique for each ASTi node.	C:\MBUILDER\BIN\ <FILENAME>.OPT	Customer-specific	No.
CUSTOM MODEL: Application-specific Model Builder file, configures RIUs, DIS Nets, voice compression types.	C:\MBUILDER\USER\MODELS\ <FILENAME>.MDL	1.04 or later	No.
CONFIGURATION FILE: This file pre-sets systems level parameters for the DIS network and selects voice compression type.	C:\MBUILDER\USER\MODELS\DEFAULT.CFG	1.04 or later	Yes. See Sections 7, 7A and 7B.
INITIALIZATION FILE: This file pre-sets the initial state of the HHT and the DIS intercom assignments for each operator.	C:\MBUILDER\USER\MODELS\ <FILENAME>.INI	1.04 or later	Yes. See Section 8 and 8A.
PATH FILE: Embedded Model Builder file	C:\MBUILDER\USER\MODELS\SYN.PTH	1.04 or later	No.
TEST UTILITIES: Files that provide built-in test utilities for the operator station interfaces.	C:\MBUILDER\USER\MODELS\TEST[VARIABLES]	1.04 or later	No.

**C.** All software modules were pre-installed during factory system integration. The system is ready to use, as shipped.

**D.** Should you need to re-install the system software, refer to Appendix B, Cold Start Procedures to re-load the operating system, Model Builder, options file and Synapse models.

## 5. ASTi HARDWARE INSTALLATION

The Synapse Workstation, including the DACS node and the RIUs, is designed to operate in benign office type environments.

### 5A. RIU Configuration

**A.** Configure the hardware settings for each RIU using the following guidelines. Refer to the Appendix A, RIU Tech Guide for physical details about: address switch and internal jumper locations.

**1. IMPORTANT:** The specified RIU settings are critical to the correct operation of the Synapse system. Each RIU is pre-configured at the factory, prior to shipping. This includes labeling “Operator RIU”, internal jumpers and external address switches. If you have any concerns that the internal settings of the RIUs have been changed from the factory settings, open the RIU case and check the settings before starting the system.

(Note that RIUs marked “Radio RIU” are configured for use with Synapse RT-Bridge.)



**2.** The RIU addresses are set on the miniature rotary switch on the RIU front face plate (the side with the TDM jacks).

**3.** The internal jumpers are accessed by removing the two faceplate screws on the RIU front face, removing the faceplate and bezel and sliding the top cover off. **IMPORTANT:** this operation must be performed at an approved ESD station to avoid damaging the equipment and voiding the manufacturer warranty.

**4.** RIU internal jumper settings:

DESCRIPTION	RIU JUMPER SETTING	”Operator RIU” (SYN-RT-04 / -08)
Input Gain, Channel A	J1	40 dB
Input Gain, Channel B	J2	40 dB
Input Gain, Channel C	J3	40 dB
Input Gain, Channel D	J4	40 dB
Output Coupling, Channel A	J5	OPEN
Output Coupling, Channel B	J6	OPEN
Output Coupling, Channel C	J7	OPEN
Output Coupling, Channel D	J8	OPEN

Jumper guide for J1 through J4:

40 dB =   

## 5B. TDM Ring Installation

**A.** Inter-connect the RIUs and the TDM card to the Synapse Workstation node using Category 5 ethernet cables (straight-through patch cord wiring). See Appendix A, section C3 for details. The cables are installed in a daisy-chain fashion, with the first cable originating at the Main Node TDM card connecting to the first RIU. The next cable links the first RIU to the second, and so on, with the last RIU being connected back to the Main Node TDM card, completing the TDM ring. Refer to Figure 3:

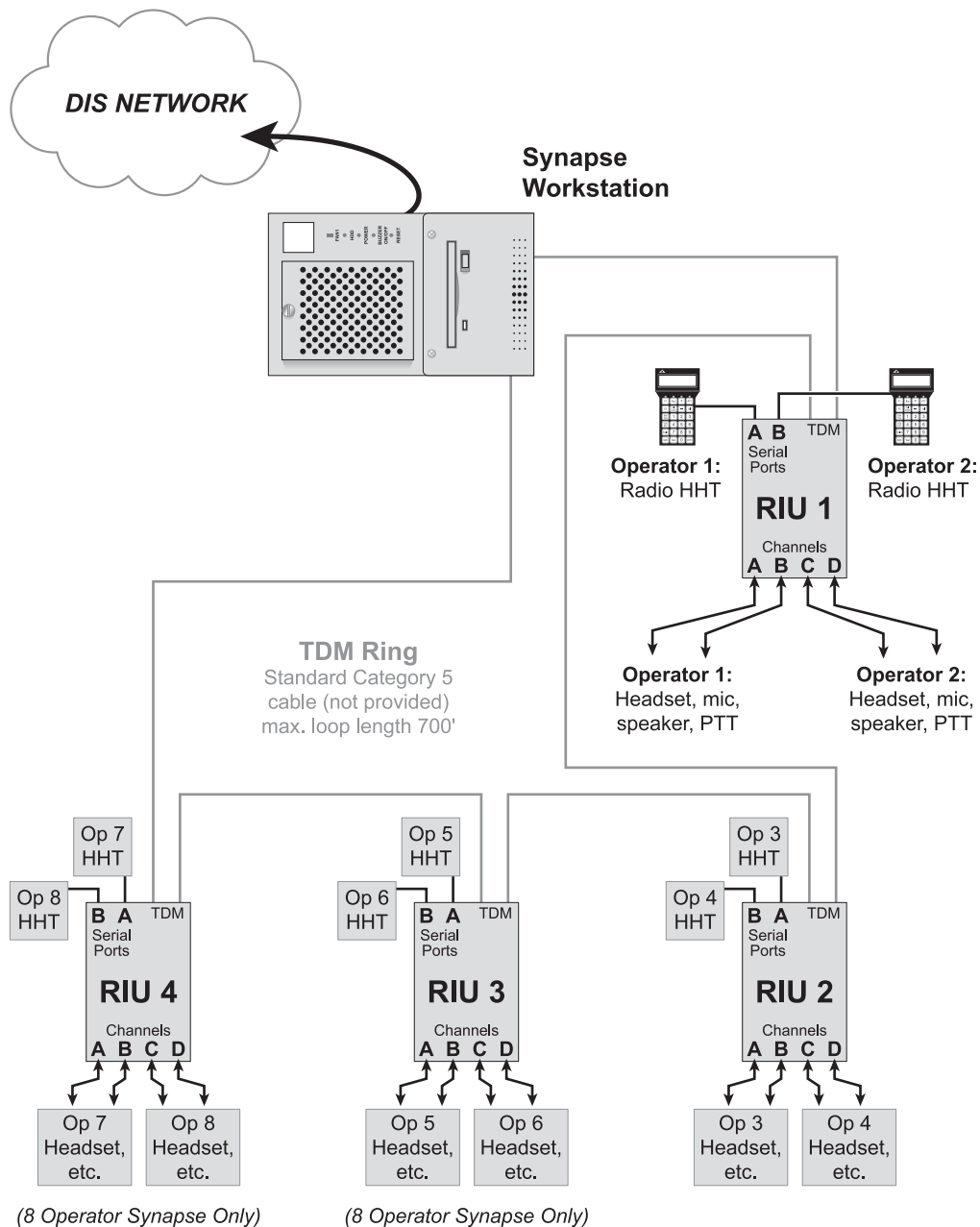

Figure 3: TDM Ring and RIU Installation

1. The RIU order (by RIU addresses) on the TDM ring is not important - they can be installed on the TDM ring in any address order.
2. It is not important which TDM socket is used for the “input” and “output” on the RIUs and TDM card.

**B. IMPORTANT:** Ensure that the correctly configured RIUs are installed with the Synapse Workstation. Only RIUs labeled “Operator RIU” should be installed. RIUs labeled “Radio RIU” were configured at the factory for use with the ASTi Synapse RT-Network Bridge system.

**C. IMPORTANT:** The maximum combined length of the TDM Cat5 cables is 700 feet. The system will not operate properly if more than 700 feet of Cat 5 cable is used to construct the TDM ring. Also note that the integrity of the Cat 5 cables is critical to the correct operation of the Synapse; we highly recommend using only commercial, premium grade cable with molded overboots as opposed to home-made cables.

### 5C. Operator Station Installation

A. Figure 3 (previous page) shows a top level view of the RIU / TDM ring installation.

B. Figure 4 (below) shows operator audio and PTT connections to the RIU.

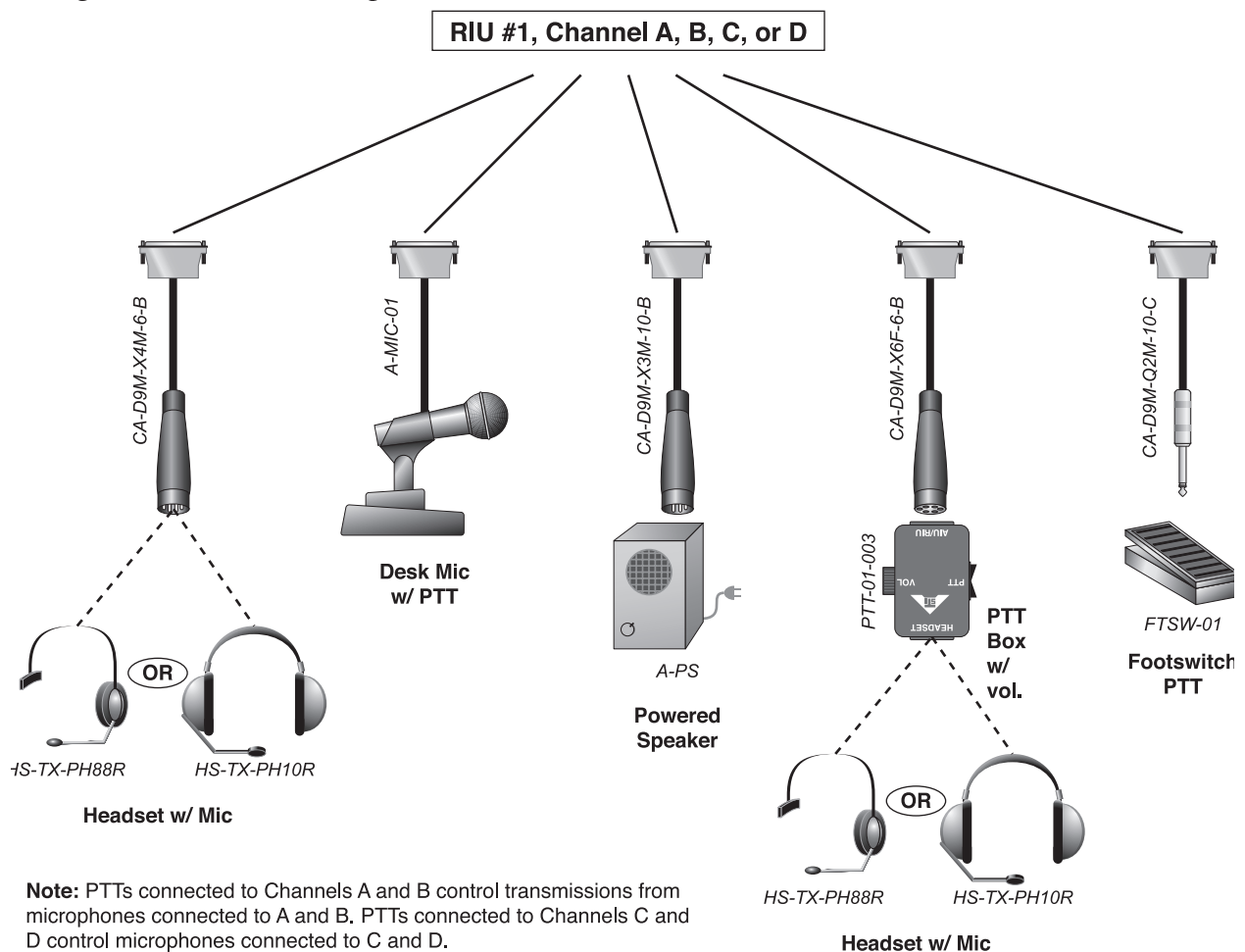

Figure 4: Operator Station Audio and Control Device Installation

**C.** Connect the Operator Station HHT, audio and PTT devices to the RIU according to the following table.

RIU Addr.	RIU Ch.	Operator #	Devices	Notes
1	A	1	Headset, PTT Box or Desk Mic with PTT	SYN-WS-04 and SYN-WS-08
1	B	1	Foot PTT or Speaker	SYN-WS-04 and SYN-WS-08
1	C	2	Headset, PTT Box or Desk Mic with PTT	SYN-WS-04 and SYN-WS-08
1	D	2	Foot PTT or Speaker	SYN-WS-04 and SYN-WS-08
2	A	3	Headset, PTT Box or Desk Mic with PTT	SYN-WS-04 and SYN-WS-08
2	B	3	Foot PTT or Speaker	SYN-WS-04 and SYN-WS-08
2	C	4	Headset, PTT Box or Desk Mic with PTT	SYN-WS-04 and SYN-WS-08
2	D	4	Foot PTT or Speaker	SYN-WS-04 and SYN-WS-08
3	A	5	Headset, PTT Box or Desk Mic with PTT	SYN-WS-08 Only
3	B	5	Foot PTT or Speaker	SYN-WS-08 Only
3	C	6	Headset, PTT Box or Desk Mic with PTT	SYN-WS-08 Only
3	D	6	Foot PTT or Speaker	SYN-WS-08 Only
4	A	7	Headset, PTT Box or Desk Mic with PTT	SYN-WS-08 Only
4	B	7	Foot PTT or Speaker	SYN-WS-08 Only
4	C	8	Headset, PTT Box or Desk Mic with PTT	SYN-WS-08 Only
4	D	8	Foot PTT or Speaker	SYN-WS-08 Only

**D.** Connect each RIU to an ASTi 5 volt power supply, then connect the power supply to power mains (110 / 220 VAC, 50 / 60 Hz).

**1. IMPORTANT:** Only use the ASTi furnished RIU power supply. Equipment damage resulting from use of substitute power supplies may not be covered by the product warranty.

## 5D. Main Node Installation

**A.** Connect a monitor and keyboard (customer-furnished) to the DACS node.

1. Keyboard connection is made through the PS/2 connector located on the rear face of the chassis. Any standard 101 key keyboard with a compliant connector type can be used.
2. Video connection is made through a female 15 pin, high density sub-D connector located on the back of the chassis. The video signal is standard VGA.

**B.** Apply power to the Synapse node.

1. **IMPORTANT:** Some ASTi DACS nodes include a manual voltage setting switch. See the rear panel of the main node. If a voltage selector switch is present, the user should select the 110 Volt or 220 Volt setting before connecting the unit to the power mains. Failure to perform this procedure may result in equipment damage which is NOT covered by the ASTi warranty.
2. If a voltage selector switch is NOT present, the particular ASTi node features an auto-sensing power supply, suitable for connection to 110 / 220 VAC, 50-60 Hz power mains. No selection is necessary.

**C.** Connect the Synapse node's DIS voice networking interface card to your DIS network using a Cat 5 cable.

## 6. INTEROPERATION WITH LIVE RTs

**A.** The ASTi Synapse Workstation can communicate with live RTs that are linked to the DIS network via the ASTi Synapse RT Bridge system.

1. Synapse RT Bridge is designed for use only with the following radio transceivers:

DESCRIPTION	MODEL
SINGGARS, SIP	RT-1523C/D
SINGGARS, ASIP	RT-1523E

**B.** Synapse RT Bridge links a live RT base unit to a DIS intercom (tuned to a particular frequency), which is accessible by operators who are connected to Synapse Workstations. For example, a Synapse RT Bridge is configured to link voice traffic from a live RT to a DIS intercom tuned to 5Hz. To intercommunicate with this live RT net, a Workstation operator would select receive and transmit access to an intercom tuned to 5Hz.

**C.** Synapse RT Bridge systems connect to the data network in exactly the same manner as Synapse Workstations. Refer to the ASTi Synapse Radio-Data Network Bridge System operator's manual for more information.

## 7. SYSTEM CONFIGURATION SOFTWARE

**IMPORTANT:** The first step toward successful setup and integration of a Synapse system is coordination between all Synapse sites to ensure that all system-level communications parameters are defined, including: a common DIS exercise ID number, common DIS receive and transmit port numbers.

**A.** System-level DIS configuration commands are stored in a pre-installed file called DEFAULT.CFG. These commands are executed when the file is automatically loaded at system startup. The user can customize the system configuration by modifying the commands in the file.

**B.** Follow the procedures in Chapter 7A to setup the DIS network configuration, including DIS IDs and network addresses and in Chapter 7B to select voice compression types.

**C. IMPORTANT:** The DEFAULT.CFG file also contains system level commands that are embedded and should not be modified by the user. These command lines are clearly marked in the file. Modification of these critical commands could disable the system, necessitating a re-load of the factory version DEFAULT.CFG file.

**D.** To customize DIS network configuration and select voice compression types you must use the DOS Edit application to open, modify and save the DEFAULT.CFG file. The general procedure for customizing the DEFAULT.CFG file is (the commands, filenames and directory paths are denoted in upper-case letters for clarity - command sequences are not case sensitive):

1. From the C:\MBUILDER\USER\MODELS prompt,
2. Enter: EDIT DEFAULT.CFG
3. Create a backup of the current DEFAULT.CFG. Enter: ALT-F-A, DEFAULT.BAK
4. Open the file, DEFAULT.CFG. Enter: ALT-F-O, DEFAULT.CFG
5. As needed, customize the commands detailed in Chapters 7A and 7B.
  - a. Command Form. Each configuration command consists of a single line in the form:  
COMMAND = PARAMETER(S)
  - b. Change command line parameters using standard DOS Edit procedures.
6. After completing file customization, save the file and exit the Edit application: Enter: ALT-F-S and ALT-F-X, respectively.
7. The configuration commands will be executed when the Synapse system is restarted (see Chapter 9 for details on starting the system).

**E.** Automatic System Defaults. Command lines that are preceded by a semi-colon are disabled, that is they are ignored when the DEFAULT.CFG is loaded at system startup. The Synapse system automatically assigns default values to the parameters of any command that has been disabled.

- 1.** For example: if the command line to set the DIS broadcast IP address is entered as ;DIS:BROADCAST\_IP = 192.30.80.255, the system will ignore the command and load the standard default value of 255.255.255.255. System default values for each command are listed in the next section.
- 2.** Some critical commands should never be disabled. These critical commands are clearly marked in the file.

**F.** The Synapse system includes monitor screens that present the system DIS configuration. After making changes to the DEFAULT.CFG file and before using the Synapse system it is recommended that you check the monitor screens to ensure that system settings are correct. See Chapter 9 for details about system startup and operational verification procedures.

**G.** In case problems result from customizing the DEFAULT.CFG file:

- 1.** Use the DEFAULT.BAK file that you created to restore the system. To restore the backup file, delete the problem DEFAULT.CFG, then rename the backup file:

At the prompt, type: `del default.cfg` and press “Enter”

At the prompt, type: `ren default.bak default.cfg` and press “Enter”

- 2.** You can also restore the system to its factory configuration by using the DOS COPY command to copy the original DEFAULT.CFG file from the Synapse Installation diskette to the Synapse working directory: Enter: `A:\COPY DEFAULT.CFG C:\MBUILDER\USER\MODELS`

## 7A. DIS Network Configuration

**A.** The DEFAULT.CFG file contains commands to preset the Synapse node's DIS configuration. Presets include:

1. Local IP address
2. Subnet Mask
3. DIS UDP Transmit and Receive Port addresses
4. Broadcast IP address
5. DIS Site and Host IDs
6. Voice Compression Type for DIS Transmission (see Section 7B)
7. The DIS Exercise ID is set using the initialization file, SYN.INI. See Section 9 for details.

**B.** Setting the DIS IP address

1. Description: Each Synapse node on the DIS network must have a unique DIS IP address. The Local IP address is used as the source IP address for all IP packets on the DIS port.
2. Syntax: DIS:LOCAL\_IP= <IP ADDRESS>, where: <IP ADDRESS> = YYY.YYY.YYY.YYY The range of each field is 0 to 255.
3. Default: The Synapse system will assign an IP address that is derived from the (unique) physical layer address of the ethernet adapter card.

**C.** Setting the DIS Subnet Mask

1. Description: The subnet mask bits, in combination with the Broadcast IP, determine the IP Broadcast addresses.
2. Syntax: DIS:SUBNET\_MASK= <MASK>, where: <MASK> = YYY.YYY.YYY.YYY, range of each field is 0 to 255.
3. Default: The Synapse system assigns the correct IP subnet mask value, based on the network class (Class A, B, C or D) of the IP address.

**D.** Setting the DIS Broadcast IP address:

1. Description: This command sets the outgoing destination address for packets on the DIS port.
2. Syntax: DIS:BROADCAST\_IP= <IP ADDRESS>, where: <IP ADDRESS> = YYY.YYY.YYY.YYY, range of each field is 0 to 255.
3. Default: 255.255.255.255

**E.** Setting the DIS UDP Port numbers to the same value, using one command:

1. Description: All of the Synapse nodes on the DIS network (both Workstations and RT Bridges) must share common DIS transmit (Tx) and receive (Rx) UDP Port numbers. This command sets the Rx and Tx ports to the same value.
2. Syntax: DIS:UDP\_PORT= <UDP PORT NUMBER>, where:  
<UDP PORT NUMBER> = YYYYY, integer, range is 0 to 65535
3. Default: RX and TX Ports = 6994

**F.** Setting the DIS UDP Port numbers independently:

1. Description: All of the Synapse nodes on the DIS network must share common DIS transmit (Tx) and receive (Rx) UDP Port numbers. This pair of commands sets the Rx and Tx ports independently.
2. Syntax: DIS:TX\_UDP\_PORT= <UDP TX PORT NUMBER> and DIS:RX\_UDP\_PORT= <UDP RX PORT NUMBER>, where:  
<UDP TX PORT NUMBER> and  
<UDP RX PORT NUMBER> = YYYYY, integer, range is 0 to 65535.
3. Default: RX and TX Ports = 6994

**G.** Setting the DIS Site and Host values:

1. Description: Each Synapse node on the data network must have a unique set of DIS Site and Host values.
2. Syntax: DIS:SITE= <SITE ID> and DIS:HOST= <HOST ID>, where:  
<SITE ID> and <HOST ID> = YYYYY, integer, range is 1 to 9999.
3. Default: Unless defined in the command line, the Site and Host IDs are automatically derived from the Local IP address. The Site ID is defined as the third field from the Local IP address and the Host ID is defined as the fourth field of the Local IP address. For example: if the Local IP address is: 192.133.120.12, then the default Site ID is 120 and the default Host ID is 12.

## 7B. Voice Compression Configuration

- A.** The Synapse system provides the user with a choice of the type of voice compression algorithm that is applied to the data network voice streams generated by the Synapse node.
- B.** Here is a guide to the two types of compression. The user should decide which factor is most critical to their application: optimal voice quality or network bandwidth conservation.
- C.** The table shows that data rates and voice quality have a direct relationship.
1. Select MuLaw if optimal voice fidelity is required and adequate network bandwidth is available.
  2. Select CVSD if network bandwidth conservation is critical and a reduction in voice fidelity is tolerable.

COMPRESSION TYPE	VOICE QUALITY	MAX. DATA RATE <sup>1,2</sup>
CVSD	Recognizable	25 kbps
MuLaw	High Quality	100 kbps

<sup>1</sup> Data Rate refers to the DIS Signal PDU data rate per network voice stream. It's expressed in kilobits per second.

<sup>2</sup> Network bandwidth consumption is fairly linear for multiple transmissions, for example: four simultaneous CVSD transmissions consume about 100 kbps of bandwidth.

- C.** You can customize the compression type for the network links by editing a DEFAULT.CFG file command line.
1. Requirement: Decide which voice compression type best suits your needs (see Chapter 7B - Lines A through C)
  2. Syntax: MODEL1= <VOICE COMPRESSION MODE>[OPS].MDL, where:  
<VOICE COMPRESSION MODE> = "MULAW" or "CVSD"  
[OPS] = The maximum number of operator interfaces available for your system (4 or 8). **DO NOT CHANGE THIS VALUE!**
  3. Default: the DEFAULT.CFG file is originally configured with MuLaw selected.
  4. **IMPORTANT:** This command should never be disabled (preceded by a semi-colon). Disabling this command will completely disable the Synapse system.

## 8. SYSTEM INITIALIZATION SOFTWARE

**A.** Commands defining the HHT presets, the DIS Exercise ID value, and DIS intercom frequency assignments are stored in a file called SYN[x]WS.INI. (The [x] signifies the maximum number of operator interfaces that are available in your system, either 4 or 8.) These commands are executed when the file is automatically loaded at system startup.

**B.** Follow the procedures in Chapter 8A to preset the HHT initialization parameters and the DIS Exercise ID value.

**C. *IMPORTANT:*** The SYN[x]WS.INI file contains some system level commands that are embedded and should not be modified by the user. These command lines are clearly marked in the file. Modification of these critical commands could disable the system, necessitating a re-load of the factory version INI file.

**D.** The DOS Edit application is used to open, modify and save the initialization file. The general procedure for customizing the initialization file is (the commands, filenames and directory paths are denoted in upper-case letters for clarity - all command sequences are not case sensitive):

1. From the C:\MBUILDER\USER\MODELS prompt,
2. Enter: EDIT SYN[x]WS.INI where [x] = either 4 (for SYN-WS-04 systems) or 8 (for SYN-WS-08 systems)
3. Create a backup of the current SYN[x]WS.INI. Enter: ALT-F-A, SYN[x]WS.BAK
4. To open the file, enter: ALT-F-O, SYN[x]WS.INI
5. As needed, customize the commands detailed in Chapter 8A.
  - a. Command Form. Each configuration command consists of a single line in the form:  
COMMAND = PARAMETER(S)
  - b. Change command line parameters using standard DOS Edit procedures.
6. ***IMPORTANT:*** Unlike the DEFAULT.CFG file, the SYN[x]WS.INI file is designed to contain no disabled commands (command lines preceded by a semi-colon). All initialization file commands must be active for the system to perform correctly.
7. After completing file customization, save the file and exit the Edit application: Enter: ALT-F-S and ALT-F-X, respectively.
8. The initialization commands will be executed when the Synapse system is restarted (see Chapter 9 for details on starting the system).

**E.** After making changes to the SYN[x]WS.INI file and before using the Synapse system it is recommended that you verify HHT operation to ensure correct system settings. After starting the system, view the HHT display for correct settings, including: Receive / Transmit status of each intercom, volumes and sidetone levels. See Chapter 9 for details about system startup and Chapter 10 operational verification procedures.

**F.** In case problems result from customizing the initialization file:

**1.** Use the SYN[x]WS.BAK file that you created to restore the system. To restore the backup file, delete the problem file, then rename the backup:

enter: DEL SYN[x]WS.INI

enter: REN SYN[x]WS.BAK SYN[x]WS.INI.

**2.** You can also restore the system to it's factory configuration by using the DOS COPY command to copy the original SYN[x]WS.INI file from the Synapse Installation diskette to the Synapse working directory:

Enter: A:\COPY SYN[x]WS.INI C:\MBUILDER\USER\MODELS

## 8A. Initialization of Operator HHT Settings, DIS Frequency and DIS Exercise ID

A. The SYN[x]WS.INI file contains commands to initialize the Synapse node's:

1. Operator access to the 16 DIS RT intercoms. Access settings for each DIS intercom are: Receive Only, Transmit / Receive and Disable (Off).
2. Lock or Unlock controls for each operator's access to intercoms
3. Master Volume and Master Sidetone levels
4. Individual volumes for each RT intercom
5. DIS Exercise ID
6. DIS intercom tuned frequency
7. All other DIS presets (Site ID, Host, ID, UDP Ports, IP addresses, voice compression type) are set in the DEFAULT.CFG file (see Section 8).

B. Setting Intercom Receive / Transmit status for each Operator

1. Description: each operator can use their HHT to access the DIS intercoms, based on initialization file settings. For each operator and each intercom, a command must be configured for one of three modes: Receive only, Transmit and Receive or Off. In addition, a Lock mode may be set for each intercom, effectively disabling the operator's ability to change communication modes from the HHT keypad.

2. **IMPORTANT:** Operators will simultaneously transmit on every DIS intercom that is set for Transmit and Receive access. This has the same effect as a single operator keying several RTs at the same time. These simultaneous transmissions create a separate network voice packet for each transmitting intercom, which has the potential to consume great amounts of network bandwidth.

3. Syntax:

```
TERMINAL:OPER_RADIO_MODE = [OP],[INTERCOM],<MODE>,<LOCK STATUS>
```

Parameter	Description
[OP]	Fixed values for operator assignments (1-4 for SYN-4-WS and 1-8 for SYN-8-WS). <b>DO NOT CHANGE VALUES!</b>
[INTERCOM]	1-16. <b>DO NOT CHANGE VALUES!</b>
<MODE>	Enter "OFF" for no Transmit or Receive, "RX" for Receive Only and "RX_TX" for Transmit and Receive.
<LOCK STATUS>	Enter "LOCK" to disable the operator's ability to change the RX/TX mode using HHT buttons. Delete this value to enable the operator's ability to change RX/TX mode using HHT buttons.

### C. Setting Master Volume and Sidetone

1. Description: Master Volume sets the main level for all intercom receptions, while Sidetone Volume sets the level for own-voice feedback during intercom transmissions.

2. Syntax:

TERMINAL:OPER\_VOL\_ST = [OP],<VOLUME>,<SIDETONE>

Parameter	Description
[OP]	Fixed values for operator assignments (1-4 for SYN-4-WS and 1-8 for SYN-8-WS). <b>DO NOT CHANGE VALUES!</b>
<VOLUME>	integer, range 0 to 9
<SIDETONE>	integer, range 0 to 9

### D. Setting Individual Intercom Volumes

1. Description: This command sets the reception volume levels for each intercom individually.

2. Syntax:

TERMINAL:OPER\_RADIO\_VOL = [OP],[INTERCOM],<VOLUME>

Parameter	Description
[OP]	Fixed values for operator assignments (1-4 for SYN-4-WS and 1-8 for SYN-8-WS). <b>DO NOT CHANGE VALUES!</b>
[INTERCOM]	1-16. <b>DO NOT CHANGE VALUES!</b>
<VOLUME>	integer, range 0 to 9

### E. Setting the Frequency Values for each DIS Intercom

1. Description: Each Synapse Workstation includes 16 DIS intercoms. This command sets the frequency value for each intercom.

2. Syntax:

TERMINAL:RADIO\_FREQ\_SQL = [INTERCOM], <FREQUENCY>

Parameter	Description
[INTERCOM]	1-16. <b>DO NOT CHANGE VALUES!</b>
<FREQUENCY>	DIS frequency, range 1 - 100,000

## F. Setting the DIS Exercise ID

**1. Description:** This command sets the DIS exercise ID that will be applied to all communications. Note that Synapse sites can inter-communicate only if they share the same DIS exercise ID.

**2. Syntax:** `TERMINAL:RADIO_EXERCISE_ID = 1,<EXERCISE ID>`

Parameter	Description
<EXERCISE ID>	integer, range 1 to 255

## 9. SYSTEM STARTUP and SHUTDOWN

- A.** Ensure that you have completed all of the steps in Sections 4 through 8.
- B.** To start the system:
  - 1.** If the Synapse node is already powered ON and resting at the system prompt:  
C:\MBUILDER\USER\MODELS, Enter: MB (not case-sensitive)
  - 2.** If the system is powered OFF, turn the Synapse node ON (the system software will load automatically) - no user responses are necessary during bootup.
- C.** The MB command:
  - 1.** Loads the system configuration file (DEFAULT.CFG) and Controller HHT initialization file (SYN.INI).
  - 2.** Launches Model Builder (ASTi's communications toolkit application) and the Custom Model (Model Builder file that is application specific to the Synapse system).
  - 3.** The system is ready for operation as soon as the Main menu appears on the screen (this is the menu beginning with the field'Models').
- D.** Proceed to the Pre-Operational System Checkout, Chapter 10.
- E.** The system is shutdown by selecting QUIT (speedkey Q) from the Main Menu.

## 10. PRE-OPERATIONAL SYSTEM CHECKOUT

**A.** The following pre-operational checkout should be performed prior to each Synapse system use and after changing system configuration and initialization files. This procedure assumes that the user has installed, configured and started the system (Chapters 5 through 9). All of the referenced software Menus and Pages are accessed through the Model Builder toolkit user interface on the main Synapse node.

1. Chapter 13 describes the use of advanced maintenance tools, useful for exercise communications coordination, realtime system monitoring and troubleshooting.

**B.** The Operational Checkout procedure should be performed in this order:

1. Errors: Chapter 10A
2. DSP Card and RIU Check: Chapter 10B
3. Model Status: Chapter 10C
4. HHT Checkout: Chapter 10D
5. DIS Network Checkout: Chapter 10E

## 10A. Error Check

**A.** Check for system level errors. Refer to Figure 5.

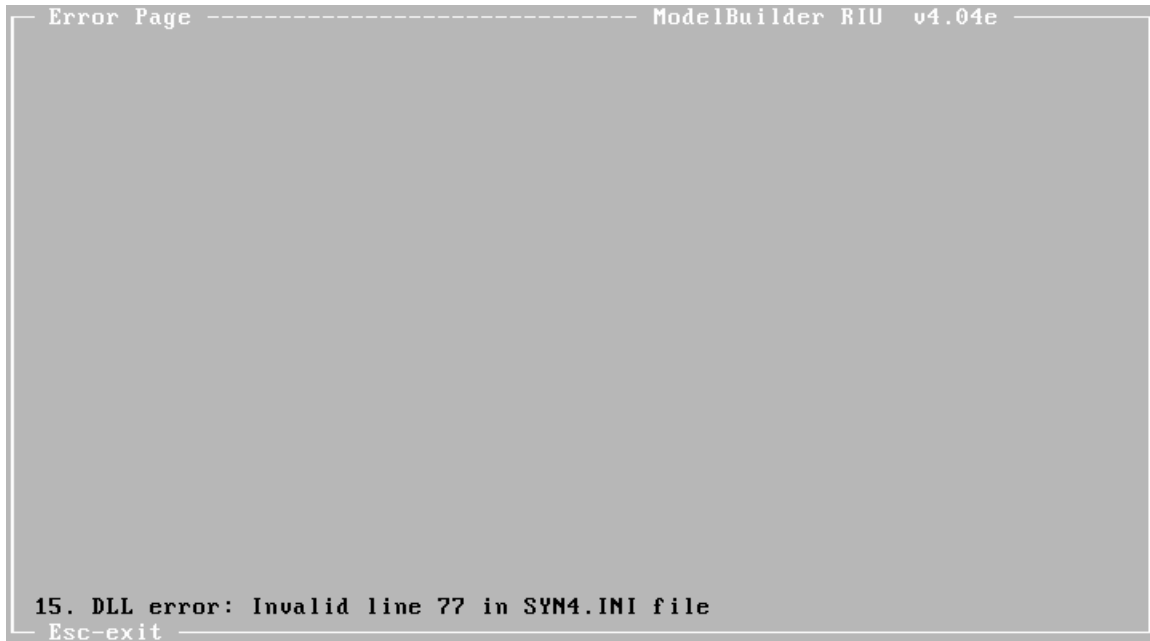

*Figure 5: Model Builder Error Pages showing Sample Error*

- 1.** From the Main Menu, go to Errors (speedkey E) and press Enter.
- 2.** There should be NO error messages.
- 3.** If any error messages are present, proceed to Chapter 14A, Troubleshooting.
- 4.** Press ESC to exit to the Main Menu.

## 10B. TDM Card and RIU Check

A. Check the TDM Card. Refer to Figure 6.

```

DSP Times / Memory Window
DSP Execution Counts
DSP Frame  Overrun

 1  6199

DSP Execution Times
DSP Frame (us) Spare (us) %    Instn
 1  125.0000  83.65885  66.9  25400          Timer=26:27
Esc-exit  PgUp/PgDn-page 1of3

```

Figure 6: Model Builder DSP Times / Memory Window

1. From the Main Menu, go to Waveform DSPs (speedkey W), then Times (speedkey T)
2. This page shows the performance metrics for the Time Division Multiplex (TDM) DSP card. The key indicators of good health for the TDM card is the DSP Execution Counts / Frame Counter. Inspect this counter to ensure that the frame count is incrementing. If the Frame Counter is not incrementing, proceed to Chapter 14B, Troubleshooting.

**B. Check the RIUs and the TDM Ring.**

1. Press Page-Down twice: go to Page 3 of 3.
2. For the SYN-WS-04 System, there should be two RIU addresses, 1 and 2, listed under the heading RIUs PRESENT. Refer to Figure 7.

```
DSP Times / Memory Window
DSP TDM Bus Status
DSP          RIUs Present
1    1    2
Esc-exit PgUp/PgDn-page 3of3
```

Figure 7: DSP Times / Memory Window for SYN-RT-04

3. For the SYN-WS-08 System, there should be four RIU addresses, 1, 2, 3 and 4 listed under the heading RIUs PRESENT. Refer to Figure 8.

```
DSP Times / Memory Window
DSP TDM Bus Status
DSP          RIUs Present
1    1    2    3    4
Esc-exit PgUp/PgDn-page 3of3
```

Figure 8: DSP Times / Memory Window for SYN-RT-08

4. If the RIUs PRESENT window does not appear as specified, proceed to Chapter 14B, Troubleshooting.
5. Press ESC twice to exit to the Main Menu.

## 10C. Software Status

**A.** Inspect the Status Page to ensure that the correct Default Model has loaded. Refer to Figure 9.

```

Status Page ----- ModelBuilder RIU v4.06

      Digital Audio and Communication System
      Model      Builder

      With Hand-Held Terminal DLL Support
      With RIU Support
      DPMI version 4.06
      Copyright ASTi 1991-98

1. Loading Options from : C:\MBUILDER\BIN\RAY0103A.OPT
2. Radio HHT DLL ver. 3
3. Radio HHT DLL ver. 3
4. DLL: DIALOGUE.DLL installed
5. DLL config file name = DEFAULT
6. Loading Commands from : DEFAULT.cfg
7. .. MODEL1=MULAW8WS.MDL
8. .. dll1 = dialogue.dll,syn8ws.ini,8
9. .. cell=on
10. .. cell:paths=synws.pth
11. .. model_rate=60
12. .. number_dsps=1
13. .. dis = on

Esc-exit

```

Figure 9: Model Builder Status Page

1. From the Main Menu, go to the Status Page (speedkey S)
2. A list of the commands that loaded during system bootup is presented.
  - a. The list should include a command line defining the Custom Model that you defined as Model1 in the DEFAULT.CFG file.
 

This is the command: MODEL1= <Compression> <OPS>WS.MDL, where: <Compression> = the type of voice compression, either MULAW or CVSD. <OPS> = the System Version: either <4> for SYN-WS-04 or <8> for SYN-WS-08.
3. If the correct “MODEL1 = “ command line did not load, proceed to Section 7B, Voice Compression Configuration and repeat the configuration procedure, entering the correct model name, and repeat the system startup (Chapter 9) and operational checkout (Chapter 10).
4. All of the other commands in the status list are critical embedded commands (they should never be altered in the DEFAULT.CFG file). If any of the other commands are not correct, the DEFAULT.CFG includes non-standard commands and the system will not operate properly.
  - a. Proceed to Chapter 14A, Troubleshooting.
5. Press ESC to exit to the Main Menu.

## 10D. Handheld Terminal Check

**A.** The Handheld Terminal (HHT) software embedded in the Main Node contains a simple offline test routine that can be triggered from the HHT keypad. This test allows the operator to verify correct operation of the HHT display and buttons. It also proves that the HHT cable is sound and that the correct HHT software is loaded from the Main Node.

**B.** To initiate the HHT self test, the system must be configured and started - see Chapter 9 for Startup.

**C.** Once the system is started, you can trigger the HHT self test by pressing the SHIFT key, then the DEL key.

**1.** Pressing any HHT key will cause a key indicator to be displayed on the screen. For example, pressing the PTT key will trigger "PTT" to be displayed on the HHT screen.

**D.** To exit the self test mode, press the SHIFT key, then the DEL key. This will place the HHT back in Synapse system service.

**E.** If the self test is not successful, proceed to Chapter 14C, Troubleshooting.

## 10E. DIS Network Check

**A.** Verify that the correct DIS configuration commands were loaded from the DEFAULT.CFG file. Refer to Figure 10.

```

D.I.S. Protocol Status Window
Local Address IP: 192.168.100.183   DIS Run      Own+Broadcast+Multicast
Subnet Mask  IP: 255.255.255.0             Local ID    Site : 100      Host : 183
Broadcast PDUs IP: 255.255.255.255        DIS Ports   RX : 6994      TX : 6994
Multicast Sigs IP: 0.0.0.0                 Multicast Mode : Single
Multicast TXs IP: 0.0.0.0                 Multicast RXs IP: 0.0.0.0

DIS TXpdus   tx: 0209 rx: 01CA           DIS SIGpdus  tx: 04F7 rx: 195E.1AA6
DIS RXpdus   tx: 01DB rx: 0227           DIS ENTpdus  rx: 0000.0000

DIS packets  tx: 04B3 rx: 1036          DIS RX Errors pdu: 0000 ck: 0000

UDP packets  tx: 04B3 rx: 1036.0000    RAW packets  tx: 0000 rx: 0000
ICMP packets tx: 0000 rx: 0000      IGMP packets tx: 0000 rx: 0000
ARP reply    rx: 0000 tx: 0000        ARP request  tx: 0000 rx: 0000

RX Byte Count : 2206520           TX Byte Count : 492494
RX Good Count  : 00001036         TX Good Count  : 000004B3
RX Errors      : 00000000         TX Errors      : 00000000

Ethernet Adapter : 1 SMC_Ultra 83C790 00-00-C0-53-41-B8 p:0300 m:CC00
Esc-exit PgUp/PgDn-page 1of2

```

Figure 10: Model Builder DIS Protocol Status Window

1. From the Main Window, Enter: DIS Network (speed-key = D), then enter: Status (speed-key = S).
  - a. **IMPORTANT:** if the DIS Network menu heading is not present in the Main Menu, there is a critical problem relating to the DEFAULT.CFG file -you should proceed to Chapter 14, Troubleshooting.
2. Your network settings are presented on the top half of the DIS Network Status page:
  - a. Local Address IP
  - b. Subnet Mask
  - c. Broadcast IP Address
  - d. DIS Ports: Receive and Transmit
  - e. Site and Host IDs
3. If any of the DIS parameters are not correct, proceed to Section 7A, DIS Network Configuration and repeat the procedure, entering the correct values, then repeat the operational check-out, Chapter 10.

**B.** Verify that the node's DIS network interface is operational. Before beginning this test ensure that: the node is booted up, operator HHTs are connected, the node is connected to the DIS network and there is at least one other Synapse node connected to the network. Each node to be tested should be manned with at least one operator with a headset and mic; each HHT should be configured for Receive and Transmit capability for one intercom.

**1.** Remain in the DIS Network Status page (or from the Main Menu: speedkey D and speedkey S). Inspect the network monitor fields:

- RX Byte Count
- RX Good Count
- TX Byte Count
- TX Good Count

**a.** All of these fields should show incrementing counters.

**b.** If the RX Good Count or TX Good Count are not incrementing (and the RX Errors and TX Errors counters are incrementing), proceed to Chapter 14, Troubleshooting. NOTE: If your Synapse node is the only one connected to the network, the RX Good Count will not be incrementing.

**2.** Ensure that the Operator HHT is initialized with at least one intercom activated for Transmit and Receive (see Chapter 8).

**a.** Press and hold the PTT (either HHT button or discrete switch) to key a network transmission.

**b.** Inspect the DIS SIG pdus tx field - it should be incrementing at a fast rate. If this counter is not incrementing, proceed to Chapter 14, Troubleshooting.

**c.** Press ESC once to go to the DIS Network Menu.

**C.** Verify that the DIS Nets from your Main Node and other Nodes connected to the network are present. Refer to Figure 11.

TX ID	Status	Frequency
TX 101:145:1:1	On	1 Hz
TX 101:145:1:101	On	1 Hz
TX 100:183:1:1	On	1 Hz
TX 100:183:1:101	On	1 Hz
TX 101:145:1:2	On	2 Hz
TX 101:145:1:102	On	2 Hz
TX 100:183:1:2	On	2 Hz
TX 100:183:1:102	On	2 Hz
TX 101:145:1:103	On	3 Hz
TX 100:183:1:103	On	3 Hz
TX 101:145:1:104	On	4 Hz
TX 100:183:1:104	On	4 Hz
TX 101:145:1:105	On	5 Hz
TX 100:183:1:105	On	5 Hz
TX 101:145:1:106	On	6 Hz
TX 100:183:1:106	On	6 Hz
TX 101:145:1:107	On	7 Hz
TX 100:183:1:107	On	7 Hz
TX 101:145:1:108	On	8 Hz
TX 100:183:1:108	On	8 Hz
TX 101:145:1:109	On_TX	9 Hz

Figure 11: Model Builder DIS Network Tx PDUs List

1. Go to the Freq of Xmitters Page (speedkey F)
2. Go to the appropriate Exercise ID page. Look at the bottom of the Freq of Xmitters page for Exercise: [N]. The default value is 1. If you have configured your Synapse to communicate using another Exercise ID, press the Plus [+] key until the appropriate Exercise ID is shown.
3. This monitor page shows all of the DIS intercoms that are detected by the Synapse node for the given DIS Exercise ID. This includes all of the DIS intercoms from your local Main Node and all of the DIS intercoms present on remote Synapse nodes (both Workstations and RT Bridges).
  - a. The DIS intercoms are identified on the list as: TX SITE: HOST: ENTITY: RADIO ID ON [FREQ] HZ

4. First ensure that there are 16 transmitters shown in yellow - these are the DIS intercoms modeled in your local Synapse Workstation node. The following table shows the all of the local (yellow) intercoms that should be present.

NET DESCRIPTION	SITE ID <sup>1</sup>	HOST ID <sup>1</sup>	ENTITY ID	RADIO ID	FREQ.
Intercom 1	User-defined	User-defined	1	1001	User-defined
Intercom 2	User-defined	User-defined	1	1002	User-defined
Intercom 3	User-defined	User-defined	1	1003	User-defined
Intercom 4	User-defined	User-defined	1	1004	User-defined
Intercom 5	User-defined	User-defined	1	1005	User-defined
Intercom 6	User-defined	User-defined	1	1006	User-defined
Intercom 7	User-defined	User-defined	1	1007	User-defined
Intercom 8	User-defined	User-defined	1	1008	User-defined
Intercom 9	User-defined	User-defined	1	1009	User-defined
Intercom 10	User-defined	User-defined	1	1010	User-defined
Intercom 11	User-defined	User-defined	1	1011	User-defined
Intercom 12	User-defined	User-defined	1	1012	User-defined
Intercom 13	User-defined	User-defined	1	1013	User-defined
Intercom 14	User-defined	User-defined	1	1014	User-defined
Intercom 15	User-defined	User-defined	1	1015	User-defined
Intercom 16	User-defined	User-defined	1	1016	User-defined

<sup>1</sup> Site ID and Host ID are defined by the user in the DEFAULT.CFG file.

a. If the specified transmitters are not present in the list, refer to Chapter 14, Troubleshooting.

5. When other Synapse nodes are connected to the DIS network, there should be a series of transmitters shown in white - these are the DIS intercoms present on remote Synapse nodes.

a. These remote DIS intercoms should be present on the list in the same form as shown in the table: TX SITE: HOST: ENTITY: RADIO ID ON [FREQ] HZ

b. If the specified transmitters are not present in the list, refer to Chapter 14F, Troubleshooting.

6. Check the list for correct DIS IDs:

a. Inspect the Freq of Xmitters list to ensure that all of the transmitters, both local (yellow) and remote (white) have unique IDs.

b. Any DIS intercoms with non-unique IDs (those sharing the same combination of Site: Host: Entity: Radio IDs) should be changed by editing the DIS:Site and DIS: Host commands in the DEFAULT.CFG file on the incorrectly configured Synapse node.

c. See Chapter 7A for the DIS configuration procedure.

**7. Helpful Hint:** Synapse Workstation and Synapse RT Bridge intercoms have unique Radio ID values, to make them easily distinguishable on the transmitters list.

- a.** Synapse Workstations assign each intercom with a Radio ID value between 1001 and 1016
- b.** Synapse RT Bridges use Radio ID values between 1 and 8 for live RT nets, 10 for Controller Private intercom, and 100 for Controller Comms.

#### **D. Network Communication Checks.**

Using the INI file (see Chapter 8), set Operator 1 HHT for transmit and receive access to Intercom 1 and set Intercom 1 frequency to 1Hz. Operator 1 and Intercom 1 should be set identically on all other networked Synapse Workstation nodes to be tested. To test a networked Synapse RT Bridge, set of the RT intercoms and the Controller Comms intercom to 1Hz. See the Synapse RT Bridge manual (DOC-01-SYN-OM-1), Chapter 8 for more information.

- 1.** Press and hold the PTT (either HHT button or discrete switch) to key a network transmission on Intercom 1.
- 2.** On the DIS Network / Status page (from the Main Menu, speedkey D and speedkey S):
  - a.** Inspect the DIS SIG PDUs TX field - it should be incrementing at a fast rate. If this counter is not incrementing, proceed to Chapter 14, Troubleshooting.
  - b.** Talk into the microphone while pressing the PTT. Request a radio check from the other Controller(s). Check for sidetone (own-voice audio). If you cannot hear sidetone audio, proceed to Chapter 14, Troubleshooting.
  - c.** Listen for received audio from other operator stations. Also inspect the DIS SIG PDUs RX counter - it should be incrementing at a fast rate. If you cannot hear received audio or the counter is not incrementing, proceed to Chapter 14, Troubleshooting.
  - d.** At this point, you should be able to communicate with all network sites with DIS intercoms tuned to 1Hz—this includes virtual Workstation operators and live Synapse RTs.
- 3.** Live RT checks, if applicable. Press and hold the HHT button to key a network transmission on a live RT Net (channels assigned to live RTs on Synapse RT Bridge nodes). Request live radio checks on the channel under test.
- 4.** On the DIS Network / Status page:
  - a.** Inspect the DIS SIG PDUs TX field - it should be incrementing at a fast rate. If this counter is not incrementing, proceed to Chapter 14F, Troubleshooting.
  - b.** Talk into the microphone while pressing the PTT. Request a comms check from the other stations, both local and networked. Check for sidetone (own-voice audio). If you cannot hear sidetone audio, proceed to Chapter 14F, Troubleshooting.
  - c.** Listen for received audio from other stations. Also inspect the DIS SIG PDUs RX counter - it should be incrementing at a fast rate. If you cannot hear received audio or the counter is not incrementing, proceed to Chapter 14F, Troubleshooting.

## 11. LIVE RT INTERCOMMUNICATIONS

**A.** The general procedure for inter-communicating with live radios connected to Synapse RT Bridge systems is identical to communicating with other Synapse Workstation operators – configure specific RTs and operator stations to common DIS intercom frequencies and exercise IDs, then talk.

**B.** Audio Quality:

1. The audio quality of transmissions from Synapse operators will be near perfect when MuLaw compression is used and somewhat degraded when CVSD compression is used.
2. The audio quality of communications from Synapse bridged live-RTs will be degraded somewhat further, due to RF propagation effects. It is critical that field and base station live RTs be installed to minimize RF pathloss. See the Synapse RT Bridge manual for details.

**C.** RT Bridge Voice Activation Performance:

1. The Synapse RT Bridge system uses a voice activation feature to sense over-the-air receive activity at the Base RT and to trigger the transmission of voice packets across the DIS network.
2. When an operator keys a Field RT push-to-talk and transmits to a Base RT, the Synapse voice activation feature is instantly keyed and network transmission begins.
3. If the Field RT operator does not speak into the handset within 2 seconds of the initial PTT, the Synapse node senses that Base RT reception has stopped and disables DIS transmission for that net.
4. As soon as the Field RT operator resumes speaking, the Synapse node resumes network transmission.
5. In this case, the receiving party on the remote side of the network may notice a very brief disruption of audio, when the operator resumes speaking after the period of silence.

**D.** Operational Note About DIS Communications

1. The Synapse system is configured such that, for a given intercom, the first communicator (live or virtual) to key a transmission, essentially “locks out” any other subsequent transmissions on that intercom. This prevents the communications interference that would result from “mixing together” multiple voice signals, were simultaneous transmissions allowed on the same DIS intercom.
2. Of course, proper radio etiquette calls for only one transmission at a time. Members of a net should release the PTT as soon as possible after completing a communication and others should wait 2 to 3 seconds before responding.

## 12. OPERATOR STATION CONCEPTS

### A. Operator Station Overview

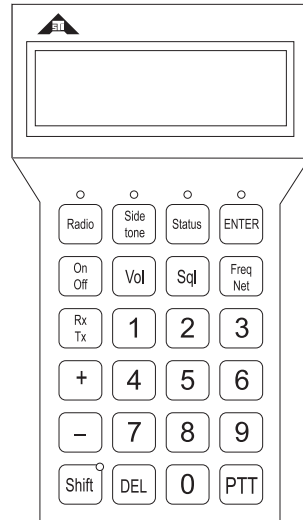

*Figure 12: Operator Station HHT Device*

**1.** The Operator Station features audio and control devices that provide a complete operator interface to the DIS network communications environment. The standard Synapse Workstation system includes sets of Operator Station ancillaries, including for each operator: a headset with mic and adapter cable and a Handheld Terminal (HHT) control device - see Figure 12.

**a.** Operator stations may include optional headsets, mics, speakers and PTTs.

**b.** The HHT provides runtime communications control settings (volume, sidetone, receive and transmit access) for the specific operator position.

**B.** The Initialization (INI) File provides pre-set values for the HHTs. At system startup, these values are automatically read into the embedded DIS modeling software application running on the Main Node and to the HHT display. See Chapter 8 for INI file usage. INI settings include:

**1.** Master Volume: overall reception volume

**2.** Sidetone Volume: “own-voice” volume for transmissions

**3.** Intercom Volumes: individual reception volume settings for each intercom

**4.** Comms Status: Receive Only, Transmit and Receive or Off, for each intercom

**a.** The INI file also features a command that is used to grant comms status change privileges to the HHT operator. If used, this command (known as the “Lock” command) disables the HHT operator's ability to change the comms status (receive, transmit or off) for each DIS intercom. This means that the presets loaded from the INI file cannot be changed by the operator.

**C.** Once the system is started (Section 10), the HHT display shows the operator’s communications status, as loaded from the INI file. This main display is called the Status Page. This page shows information relating to the DIS environment, from the operator’s vantage point.

- 1.** The top line of the Status Page contains the identifier position, for example: “OPERATOR\_1”.
- 2.** The second line contains a line of numbers representing each DIS intercom.
- 3.** The third and fourth lines of the display are: receive (RX) and transmit (TX) lines. Access to each intercom is represented by a symbol showing its current state.
  - a.** An intercom selected for receive and transmit is represented by a R in the RX line and a T in the TX line.
  - b.** Receive only is shown as a R in the RX line and a period (.) in the TX line.
  - c.** If access to the intercom is disabled (Off in the INI file), the display shows a period in both the TX and RX lines for that intercom.

**D.** Example: for a system with INI file presets:

- Status = Receive Only for intercoms 1 through 4.
- Status = Off for intercoms 5 through 15.
- Status = Receive and Transmit for intercom 16.
- Master Volume = 7
- Sidetone Volume = 5

The HHT Status Page displays:

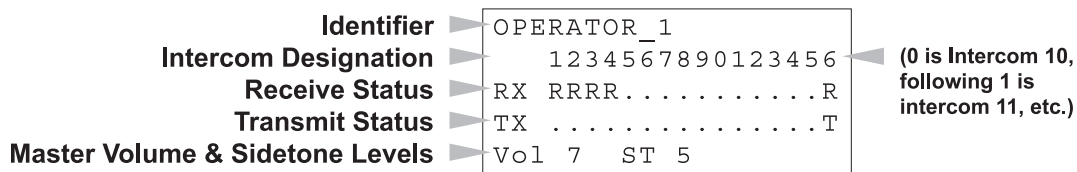

**E.** HHT Communications Activity Indication

- 1.** When the operator is transmitting or receiving, the active Intercom Designator number(s) on the HHT changes to an asterisk (\*) and the red LED located above the ENTER key illuminates.





## 12A. Operator Station Operation

**A.** Operator Station communications parameters can be set using the HHT keys after the system is running. The user can modify the following parameters: Master Volume, Intercom Volume (for each intercom), Sidetone, Intercom Access - Receive, Receive and Transmit or Off.

**B.** The user's ability to use the HHT to change the Receive and Transmit access to specific intercoms may be disabled through the LOCK command in the INI file (see Chapter 8). HHT controls that may be effected by the LOCK command are specified in the following sections.

### C. HHT Keypad Operation





#### 1. Master Volume

From the main Status screen, press  then either press the numeric key 0-9 for the desired volume, or ramp up or down using  and  followed by .

*Operator Volume Page*

```
Operator: 1
Volume: 5
```

#### 2. Sidetone



From the main Status screen, press  then either press the numeric key 0-9 for the desired sidetone, or ramp up or down using  and  followed by .

*Operator Sidetone Page*

```
Operator: 1
Sidetone: 5
```

### 3. Transmit and Receive Access (Lock command disables)

The operator can also select a particular intercom for transmission and any series of intercoms for passive monitoring. This can be accomplished most simply by use of the “hot keys”

described later. An alternative method is to use ,  and  keys while in the Radio Status page.

Pressing  will bring up the Intercom Status page. The intercom displayed will default to the last intercom selected by a hot key sequence or the first intercom if no hot key sequence has been used.

#### *Intercom Status Page*

```
Intercom: 01  
  
Status: OFF  
Volume: 5
```

Pressing  from this screen will toggle the mode of that intercom (shown in the “Status” field) between OFF (silent) and RX.

Pressing  will toggle the mode of that intercom between RX and RX\_TX.

### 4. HHT Controls Overview

#### HHT Operation (Main Status Page)

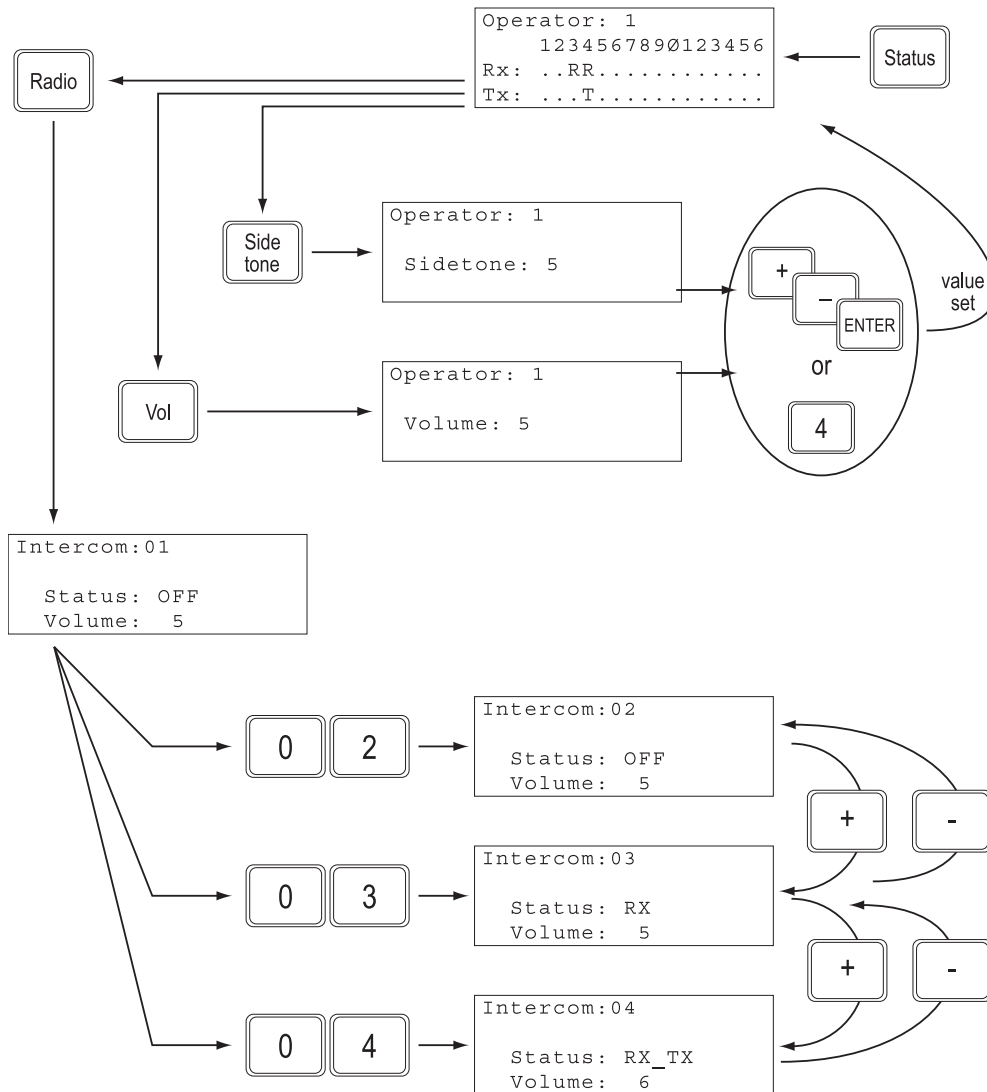

*HHT Operation (Radio Status Page)*

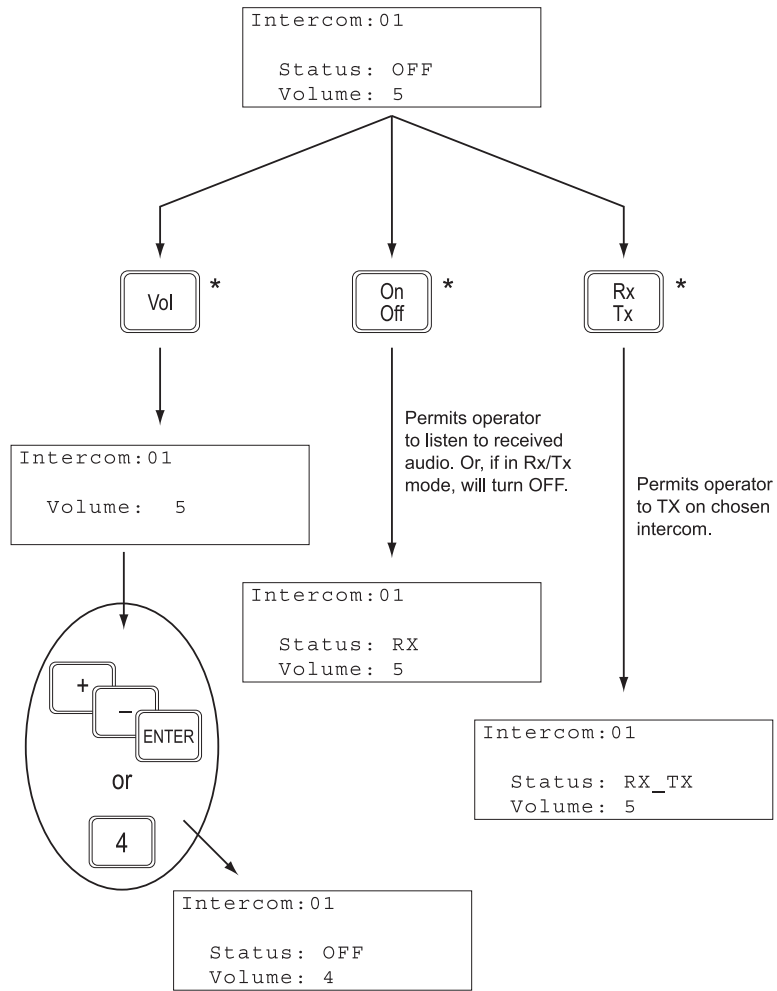

\* This control affects how individual operator audio is routed (and its level) to/from a simulated intercom.

### 5. Hot Keys (Lock command disables)

This Main Status Page mode employs a “hot key” concept to access the most frequently required functions:

To select a particular intercom to Transmit and Receive, press the two-digit number (e.g., 01, 02, 15, etc.) of the intercom from the Status Page. To turn off a Transmit/Receive intercom, press **Shift** followed by the two-digit intercom number.

#### Hot Key Operation Rx/Tx

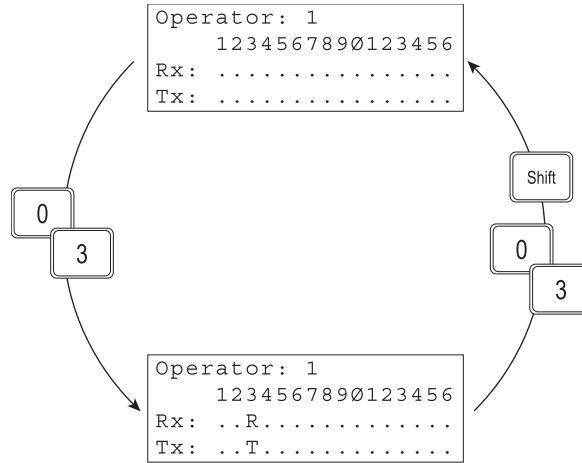

**Note:** Use of the hot key method for selection of transmit status selects only a single intercom for transmission at any one time. Using the method described in the previous section, an operator may select multiple intercoms for simultaneous transmission.

To select additional intercoms to be monitored in the Receive-Only mode, press **Shift** followed by the two-digit intercom number. To turn off a Receive-Only intercom, press **Shift** followed by the two-digit intercom number again.

#### Hot Key Operation Rx-only

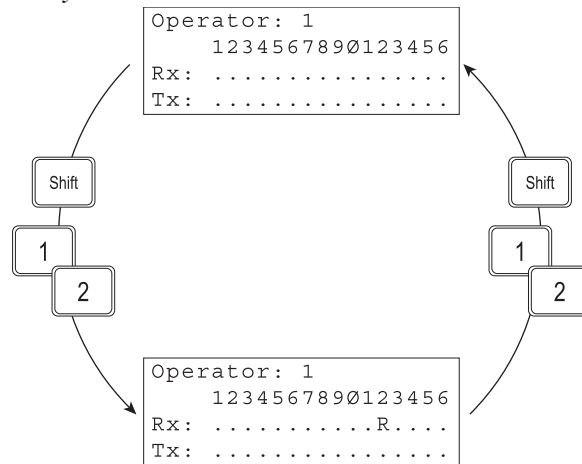

**D. Push to Talk (PTT) Operation**

1. Activating an operator's PTT switch (either from the HHT or a discrete hand or foot switch) connected to the RIU will key transmissions for all DIS intercoms selected for Transmit and Receive access (shown as T and R on the HHT display, respectively).

2. Specific PTTs control the activation of specific microphones:

OP #	RIU ADDR	PTT SOURCE: HHT –OR– Discrete PTT Channel		MIC SOURCE	NOTES
1	1	HHT, Serial Port A	Channel A or B	Channel A or B	SYN-WS-04 and -08
2	1	HHT, Serial Port B	Channel C or D	Channel C or D	SYN-WS-04 and -08
3	2	HHT, Serial Port A	Channel A or B	Channel A or B	SYN-WS-04 and -08
4	2	HHT, Serial Port B	Channel C or D	Channel C or D	SYN-WS-04 and -08
5	3	HHT, Serial Port A	Channel A or B	Channel A or B	SYN-WS-08 Only
6	3	HHT, Serial Port B	Channel C or D	Channel C or D	SYN-WS-08 Only
7	4	HHT, Serial Port A	Channel A or B	Channel A or B	SYN-WS-08 Only
8	4	HHT, Serial Port B	Channel C or D	Channel C or D	SYN-WS-08 Only

## 13. ADVANCED MAINTENANCE TOOLS

### A. Synapse Maintenance Tools, General

1. This chapter describes Synapse advanced maintenance tools that provide an effective means to monitor and maintain system communications both during communications sessions and off-line.
2. These advanced tools are also used in conjunction with the troubleshooting procedures in Chapter 14.
3. Chapter 10 presents basic maintenance tools that are used for pre-operational check-out procedure and troubleshooting procedures.

### B. Synapse System Maintenance Tools

#### 1. Operator Station

- a. The operator Station can receive and transmit on any of the 16 available DIS intercoms, based on the INI file presets (Chapter 8) and the HHT keypad settings (Chapter 12).
- b. This feature provides the operator with a powerful tool that is capable of monitoring voice communications or performing 'comms checks' to and from any of the DIS intercoms, for both local and networked sites.
- c. For system-wide transmit and receive capability, the INI file must be set up to allow operator access to HHT keypad selection for transmit and receive on all intercoms (the LOCK command cannot be invoked for any intercom).

### C. DIS Network Monitoring Utilities

1. ASTi's Model Builder communications software provides a DIS Network menu that provides local node and network-wide monitors.
2. Under the DIS Network menu, is the DIS Status page, a utility that shows local node DIS configuration, including: Local IP address, Broadcast IP Address, UDP Ports, Subnet Mask, Site ID and Host ID. This page allows the user to check the node configuration presets, loaded from the DEFAULT.CFG file (Chapter 7), in real-time. See Chapter 10F for details.
3. The DIS Status page also features a series of counters that indicate good and bad transmit and receive packet counts at the IP and UDP level for DIS Receive, Transmit and Signal PDUs. These counters provide a utility that is useful for diagnosing network-level problems. These are described in Chapter 10F.
4. Also under the DIS Network menu is a series of lists (Freq of Xmitters, Local Xmitters, Transmitters, Receivers and Local Receivers) that provide the user with a network-wide view that is invaluable during exercise coordination or troubleshooting. These lists show local and network Transmit and Receive PDUs for a selected DIS exercise ID.
5. To view any of the lists, you will have to navigate to the appropriate Exercise ID page. After entering a particular list, look at the bottom of the page for Exercise: [N]. The default value is 1. If you have configured your Synapse to communicate using another Exercise ID, press the Plus [+] key until the appropriate Exercise ID is shown.

6. Each page shows the DIS intercoms that are detected by the Synapse node for the given DIS Exercise ID.
7. Highlighting a specific DIS intercom (arrow up or down keys) and pressing Enter will bring up a screen that displays the PDU header information (Site, Host, Entity, Frequency).
8. The DIS Lists include:
  - a. Freq of Xmitters (From the Main Menu: speedkey D - speedkey F). See Figure 13.

TX ID	Status	Frequency
TX 101:145:1:1	On	1 Hz
TX 101:145:1:101	On	1 Hz
TX 100:183:1:1	On	1 Hz
TX 100:183:1:101	On	1 Hz
TX 101:145:1:2	On	2 Hz
TX 101:145:1:102	On	2 Hz
TX 100:183:1:2	On	2 Hz
TX 100:183:1:102	On	2 Hz
TX 101:145:1:103	On	3 Hz
TX 100:183:1:103	On	3 Hz
TX 101:145:1:104	On	4 Hz
TX 100:183:1:104	On	4 Hz
TX 101:145:1:105	On	5 Hz
TX 100:183:1:105	On	5 Hz
TX 101:145:1:106	On	6 Hz
TX 100:183:1:106	On	6 Hz
TX 101:145:1:107	On	7 Hz
TX 100:183:1:107	On	7 Hz
TX 101:145:1:108	On	8 Hz
TX 100:183:1:108	On	8 Hz
TX 101:145:1:109	On_TX	9 Hz

Enter/CtrlEnter - Display Esc-exit Exercise: 1 Line: 1

Figure 13: Model Builder DIS Network Tx PDUs List

- i. This list shows all local and remote DIS transmitter PDUs for a specific DIS exercise.
- ii. The list is sorted by frequency, in Hertz
- iii. Transmitter PDUs from the local Synapse node are shown in yellow text.
- iv. Transmitter PDUs from remote network Synapse nodes are shown in white text.
- v. Local or remote transmitters that are actively transmitting are shown as:  
TX SITE: HOST: ENTITY: RADIO ID ON\_TX [FREQ] HZ

**b. Transmitters** (From the Main Menu: speedkey D - speedkey T). See Figure 14.

TX ID	Status	Frequency
101:145:1:1	On	1 Hz
101:145:1:3	On	14 Hz
101:145:1:2	On	2 Hz
101:145:1:4	On	15 Hz
101:145:1:101	On	1 Hz
101:145:1:102	On	2 Hz
101:145:1:103	On	3 Hz
101:145:1:109	On_TX	9 Hz
101:145:1:105	On	5 Hz
101:145:1:110	On_TX	10 Hz
101:145:1:111	On	11 Hz
101:145:1:108	On	8 Hz
101:145:1:107	On	7 Hz
101:145:1:106	On	6 Hz
101:145:1:104	On	4 Hz
101:145:1:112	On	12 Hz
101:145:1:113	On	13 Hz
101:145:1:116	On	16 Hz
101:145:1:114	On	14 Hz
101:145:1:115	On	15 Hz

Figure 14: Model Builder DIS Network Tx PDUs List

- i. This list shows all remote DIS transmitter PDUs for a specific DIS exercise.
- ii. Transmitter PDUs from the network Synapse nodes are shown in white text.
- iii. Remote transmitters that are actively transmitting are shown as:  
TX SITE: HOST: ENTITY: RADIO ID ON\_TX [FREQ] HZ

**c. Local Transmitters** (From the Main Menu: speedkey D - speedkey L). See Figure 15.

TX ID	Status	Frequency
100:183:1:1	On	1 Hz
100:183:1:2	On	2 Hz
100:183:1:3	On	14 Hz
100:183:1:4	On	15 Hz
100:183:1:101	On_TX	1 Hz
100:183:1:102	On	2 Hz
100:183:1:103	On	3 Hz
100:183:1:104	On	4 Hz
100:183:1:105	On_TX	5 Hz
100:183:1:106	On	6 Hz
100:183:1:107	On	7 Hz
100:183:1:108	On_TX	8 Hz
100:183:1:109	On	9 Hz
100:183:1:110	On	10 Hz
100:183:1:111	On	11 Hz
100:183:1:112	On	12 Hz
100:183:1:113	On	13 Hz
100:183:1:114	On	14 Hz
100:183:1:115	On	15 Hz
100:183:1:116	On_TX	16 Hz

Figure 15: Model Builder DIS Network Local Tx PDUs List

- i. This list shows all local DIS transmitter PDUs for a specific DIS exercise.
- ii. Local transmitters that are actively transmitting are shown as:

TX SITE: HOST: ENTITY: RADIO ID ON\_TX [FREQ] HZ

d. Receivers (From the Main Menu: speedkey D - speedkey R). See Figure 16.

RX ID	Status	Frequency (Hz)
RX 101:145:1:1	On_RX	30.0000000
RX 101:145:1:2	On	
RX 101:145:1:3	On	
RX 101:145:1:4	On	
RX 101:145:1:101	On_RX	30.0000000
RX 101:145:1:102	On	
RX 101:145:1:103	On	
RX 101:145:1:109	On	
RX 101:145:1:104	On	
RX 101:145:1:111	On	
RX 101:145:1:105	On_RX	30.0000000
RX 101:145:1:106	On	
RX 101:145:1:110	On	
RX 101:145:1:107	On	
RX 101:145:1:108	On_RX	30.0000000
RX 101:145:1:114	On	
RX 101:145:1:115	On	
RX 101:145:1:113	On	
RX 101:145:1:112	On	
RX 101:145:1:116	On_RX	30.0000000

Enter/CtrlEnter - Display Esc-exit Exercise: 1 Line: 1

Figure 16: Model Builder DIS Network Rx PDUs List

i. This list shows all remote DIS receiver PDUs for a specific DIS exercise.

ii. Remote receivers that are actively receiving are shown as:  
RX SITE: HOST: ENTITY: RADIO ID ON\_RX [FREQ] HZ

e. Local Receivers (From the Main Menu: speedkey D - speedkey V). See Figure 17.

RX ID	Status	Frequency (Hz)
RX 100:183:1:1	On	
RX 100:183:1:2	On	
RX 100:183:1:3	On	
RX 100:183:1:4	On	
RX 100:183:1:101	On	
RX 100:183:1:102	On	
RX 100:183:1:103	On	
RX 100:183:1:104	On	
RX 100:183:1:105	On	
RX 100:183:1:106	On	
RX 100:183:1:107	On	
RX 100:183:1:108	On	
RX 100:183:1:109	On_RX	30.0000000
RX 100:183:1:110	On_RX	30.0000000
RX 100:183:1:111	On	
RX 100:183:1:112	On	
RX 100:183:1:113	On	
RX 100:183:1:114	On	
RX 100:183:1:115	On	
RX 100:183:1:116	On	

Enter/CtrlEnter - Display Esc-exit Exercise: 1 Line: 1

Figure 17: Model Builder DIS Network Local Rx PDUs List

i. This list shows all local DIS receiver PDUs for a specific DIS exercise.

ii. Local receivers that are actively receiving are shown as:

---

RX SITE: HOST: ENTITY: RADIO ID ON\_RX [FREQ] HZ

**D. Node Performance Utility – TDM Card and RIUs**

1. Synapse includes a series of Waveform DSP monitor pages that present node performance parameters for the Time Division Multiplex Digital Signal Processor (TDM DSP) and the Remote Interface Units (RIUs). This monitor indicates the general health of the internal TDM card and whether RIUs have been configured and installed properly.
2. Refer to Chapter 10B for details.

**E. Operator Station Audio and PTT Offline Test**

1. An off-line utility is provided that tests the audio inputs (microphone), audio outputs (speaker) and discrete digital inputs (PTT) for all RIU channels.
2. Ensure that the system is running and that you have installed at least one operator station audio (and if applicable, optional PTT) configuration. This test requires a known-good TDM ring. Check the RIU / TDM Ring (Chapter 10B) before attempting the operator offline test.
3. Quit the Synapse application before running the utility: speedkey Q from the Main Menu.
  - a. Then from the prompt: C:\MBUILDER\USER\MODELS
  - b. Enter: CD TEST
  - c. Then enter: TESTCON
4. For each RIU, this utility loops audio from each of the RIU microphone inputs to all of the RIU speaker outputs. Check for overall audio quality and proper audio level. A periodic tone pulse is also heard.
5. To test each of the PTT inputs (Channels A, B, C and D), simply press the PTT switch. This will trigger a momentary tone that is heard at all RIU speaker outputs.
6. If the system does not pass the audio loop or PTT tests, proceed to Chapter 14, Troubleshooting.
7. To quit the offline Controller test enter: speedkey Q from the Main Menu.
  - a. This will leave you at the prompt: C:\MBUILDER\USER\MODELS\TEST.
  - b. To return the Synapse runtime directory, enter: CD.

**F. Offline HHT Test**

1. Synapse includes an offline HHT test that can be triggered from the HHT keypad. This test allows the operator to verify the following:
  - a. Correct operation of the HHT display and keypad
  - b. Soundness of the HHT cable
  - c. Soundness of the TDM cables
  - d. Correct RIU address

- e. Correct HHT software configuration on the Main Node.
- f. See Chapter 10D for guidance.

### G. Advanced HHT Tests

1. Synapse also includes a HHT software monitor page in the Model Builder communications toolkit that displays the embedded software status and the presence of display message and key press control communications between the HHT, the RIU, the TDM ring and the main node.
2. To access the HHT monitor page, from the Main Menu, go to Cell Interface (speedkey C), then DLL Status (speedkey D).
3. Page 1 of 3: Look for slow incrementing counts in both the Put No and Get No columns. Press any key on the HHT; the Put No and Get No counts should increment with each key entry. See Figure 18.

```

DLL Status Window
DLL Counters
DLL PutNo  GetNo
1      0040  023C
2      ----  ----
3      ----  ----
4      ----  ----
5      ----  ----
6      ----  ----
7      ----  ----
8      ----  ----
Esc-exit  PgUp/PgDn-page 1of3

```

Figure 18: Model Builder DLL Status Window, 1 of 3

4. Enter: Page Down to Page 2 of 3: Look for the presence of a library file called “DIALOGUE.DLL”. See Figure 19.

```

DLL Status Window
DLL Versions
DLL Vers   Library File
1      1      DIALOGUE.DLL
2
3
4
5
6
7
8
Esc-exit  PgUp/PgDn-page 2of3

```

Figure 19: DLL Status Window, 2 of 3

5. Enter: Page Down to Page 3 of 3: Look for the presence of a configuration file called “SYN <OP>WS.INI, where <OP> is 4 for a SYN-WS-04 system and 8 for a SYN-WS-08 system. See Figure 20.

```
— DLL Status Window —
DLL Config files
DLL Error  Credit Config File

1          4400  SYN8WS.INI
2
3
4
5
6
7
8
— Esc-exit  PgUp/PgDn-page 3of3 —
```

Figure 20: DLL Status Window, 3 of 3

6. If the results of any of these tests is negative, proceed to Chapter 14C, Controller HHT Troubleshooting.

## 14. SYSTEM TROUBLESHOOTING

**A.** The system checkout procedure outlined in Chapter 10 should always be performed before operating the Synapse system. If you are experiencing operational problems and didn't perform the system checkout procedure, you should shut down and re-start the system, then methodically step through the system checkout.

**B.** If you still experience problems after running the checkout procedure, follow the troubleshooting procedures described in Chapter 14 to isolate and fix the source of system problems.

**C.** Unless specified otherwise, or it is obvious to the user that the source of a problem resides at a particular site, these procedures should be executed at all nodes.

**D. HINTS:**

**1.** Coordination between site operators can expedite the fault isolation process. If the network communications problems don't inhibit your ability to talk with other site operators, make a quick call to verify if the problem is local to your site or system-wide.

**2.** Communication problems encountered during initial startup are most likely related to basic user configuration problems: RIU / TDM hardware installation, script file commands for DIS exercise ID, site and host IDs, Base RT Channel assignments and network configuration. The radio link between Base RTs and Field RTs is also a likely source of initial problems for Synapse RT Bridges.

## 14A. Main Node Troubleshooting / Error Messages

### A. Problem:

System doesn't respond to keyboard entries.

*Suggestion:*

Reset the main node by pressing the front panel Reset button. If the problem persists, contact ASTi support.

### B. Problem:

Error message: "Interrupt Jumper Missing"

*Suggestion:*

Reset the main node by pressing the front panel Reset button. If the error message persists, contact ASTi support.

### C. Problem:

Error message: "DSP1 Failed at Startup"

*Suggestion:*

Reset the main node by pressing the front panel Reset button. If the error message persists, contact ASTi support.

### D. Problem:

Incorrect commands are observed in the Status Page (from the Model Status procedure in Chapter 10C).

*Suggestion:*

If the Model1= <FILENAME> command is incorrect, repeat the DIS Configuration procedure in Chapter 7B.

If any of the other commands are incorrect, your DEFAULT.CFG file needs to be repaired or re-loaded. To repair the file, refer to the list of commands in Chapter 10C and edit the file to revise the incorrect command. Then save and exit. The alternative is to re-load the file from either your backup copy or from the original Synapse model installation disk. To install from the model installation disk, use the command: COPY A:\DEFAULT.CFG  
C:\MBUILDER\USER\MODELS

### E. Problem:

Error message: "DLL error... ini".

*Suggestion:*

The system initialization file (INI file) contains commands with incorrect syntax. Repeat the procedures in Chapter 8, System Initialization to revise the INI file.

## **F. Problem:**

Error message: "Stream Open Error: File Not Found Model".

### ***Suggestion:***

The Model1= <FILENAME> command is incorrect. Repeat the DIS Configuration procedure in Chapter 7B.

## **G. Problem:**

Error message: "Cannot Open Command File Default.Cfg"

### ***Suggestion:***

This message will occur if you attempt to start the system (command: MB) from the incorrect directory. Ensure that you are starting the system by entering "MB" from the directory: C:\MBUILDER\USER\MODELS. This message will also occur if the DEFAULT.CFG file is missing from the...\MODELS directory. To look for the file, from the C:\MBUILDER\USER\MODELS directory, enter: DIR \*.CFG.

If the DEFAULT.CFG file is missing, re-load it from either your backup copy or from the original Synapse model installation disk. To install from the model installation disk, use the command: COPY A:\DEFAULT.CFG C:\MBUILDER\USER\MODELS

## **H. Problem:**

Error message: "No Valid Option File ..."

### ***Suggestion:***

The system software option file is missing or corrupted. In either case, you must reload it from the original Option Installation disk. Insert the disk in the floppy drive and enter: A:\INSTALL. If you don't have an option install disk, contact ASTi support.

## **I. Problem:**

Error message: "Credits Exhausted at..." (SYN-WS-04 systems only)

### ***Suggestion:***

Software for an 8-operator Synapse system has been loaded into a 4-operator system. To restore system operation, you must reload the Synapse system software. Insert the installation diskette, enter "install", then follow the prompts. Enter "4" when prompted for the number of nets.

## **J. Problem:**

Error message: "DLL error: File <filename.ini> not found"

### ***Suggestion:***

One of the critical embedded commands in the DEFAULT.CFG file has been corrupted. Re-load the DEFAULT.CFG file from either your backup copy or from the original Synapse model installation disk. To install from the model installation disk, use the command: COPY A:\DEFAULT.CFG C:\MBUILDER\USER\MODELS

**K. Problem:**

Error message: "Cannot open Command File Default.Pth"

***Suggestion:***

One of the critical embedded commands in the DEFAULT.CFG file has been corrupted. Reload the DEFAULT.CFG file from either your backup copy or from the original Synapse model installation disk. To install from the model installation disk, use the command: COPY A:\DEFAULT.CFG C:\MBUILDER\USER\MODELS

**L. Problem:**

Error message: "DLL load error <filename.dll>"

***Suggestion:***

One of the critical embedded commands in the DEFAULT.CFG file has been corrupted. Reload the DEFAULT.CFG file from either your backup copy or from the original Synapse model installation disk. To install from the model installation disk, use the command: COPY A:\DEFAULT.CFG C:\MBUILDER\USER\MODELS

## 14B. TDM and RIU Troubleshooting

### A. General:

1. Perform the TDM Card and RIU checkout procedure, Chapter 10B, then follow this procedure:
2. NOTE: A healthy TDM ring is indicated by:
  - a. All RIUs on the ring show green lights, flashing at a once per second rate -AND-
  - b. The correct RIU addresses are shown on the Waveform DSP / Times / RIU Present page in Model Builder. See Chapter 10B for more guidance.

### B. Problem:

No lights are illuminated on one or more of the RIUs.

#### *Suggestion:*

Ensure that: the RIU power supply is securely mated to the RIU, the detachable AC cord is securely mated to the power supply and that AC power (110 to 240 VAC, 50/60 Hz) has been applied to the power supply. Substitute power supply or AC cord as necessary to isolate and correct faults.

### C. Problem:

The RED lights are illuminated on all RIUs.

#### *Suggestion:*

The main node is not running. Start the system, inspect the Error page and fix any error messages (Chapter 14A).

### D. Problem:

The RED and GREEN lights are both lit.

#### *Suggestion:*

Press the RIU Reset button located on the front faceplate.

### E. Problem:

The GREEN light on one or more of the RIUs is blinking at a fast rate (about 4 times per second).

#### *Suggestion:*

Possible causes include: incorrect model running on the main node, one or more of the RIUs is incorrectly addressed or there is one or more faulty TDM cables in the ring.

**Step 1)** Inspect the Error list for error messages. Make corrections as needed. See Chapter 14A for guidance.

**Step 2)** Ensure that the RIU addresses are correctly set: Address 1 = Operators 1 & 2, Address 2 = Operators 3 & 4, Address 3 = Operators 5 & 6, Address 4 = Operators 7 & 8 (see Chapter 5A for guidance).

**Step 3)** Ensure that all of the Category 5 TDM cables are correctly installed and securely mated at each connector on the RIUs and the TDM card. See Chapter 5C for TDM ring installation guidance.

**Step 4)** Check the Category 5 TDM cables, substitute with spare cables to isolate faults, then restart the system.

**NOTE:** RIU lights can indicate the location of a TDM ring fault. For example: if RIU 1 and RIU 2 both have slow blinking GREEN lights and RIU 3 has a fast blinking GREEN light, there is most likely a faulty cable between RIU 2 and RIU 3 -OR- RIU 3 is addressed incorrectly.

#### **F. Problem:**

For SYN-WS-08 systems only: The GREEN lights on RIU addresses 1 and 2 blink slowly and addresses 1 and 2 are shown on the Waveform DSP / Times / RIU Present page. The GREEN lights on RIU addresses 3 & 4 blink fast and RIU addresses 3 & 4 are not present on the RIU Present page.

#### **Suggestion:**

Software for a 4-operator Synapse Workstation system has been loaded on an 8-operator system. To restore system operation, you must reload the Synapse system software. Insert the installation disk, enter: "install", then follow the prompts. Enter "8" when prompted for the number of operators.

#### **G. Problem:**

The GREEN lights on all of the RIUs are flashing once per second, but not all of the correct RIU addresses are displayed on the Waveform DSP / Times / RIUs Present page.

#### **Suggestion:**

Step 1) Ensure that all of the Category 5 TDM cables are securely mated at each connector on the RIUs and the TDM card. Step 2) Check the Category 5 TDM cables, substitute with spare cables to isolate faults, then reset all RIUs and restart the system.

## 14C. Operator HHT Troubleshooting

### A. Problem:

The HHT does not pass the HHT Check test procedure (Chapter 10D).

#### *Suggestion:*

**Step 1)** Ensure that there are no error messages listed. See Chapter 14A for guidance.

**Step 2)** Perform the TDM Card and RIU check, Chapter 10B. If the results are negative, follow the procedures in Chapter 14B to correct problems.

**Step 3)** Ensure that the HHT is connected to correct RIU address and serial port (see installation diagram in section 5B).

**Step 4)** Perform the Advanced HHT test in Chapter 13, item H.

#### *Page 1 of 3 test results:*

The Put No and Get No counts should be slowly incrementing (with no HHT key presses). If both aren't incrementing: One of the critical embedded commands in the DEFAULT.CFG file has been corrupted. Re-load the DEFAULT.CFG file from either your backup copy or from the original Synapse model installation disk. To install from the model installation disk, use the command: COPY A:\DEFAULT.CFG C:\MBUILDER\USER\MODELS HHT keypresses should cause both the Put No and Get No counts to increment once per key entry. If not:

**Either:** One of the critical embedded commands in the DEFAULT.CFG file has been corrupted. Re-load the DEFAULT.CFG file from either your backup copy or from the original Synapse model installation disk. To install from the model installation disk, use the command: COPY A:\DEFAULT.CFG C:\MBUILDER\USER\MODELS

**Or:** The HHT-to-RIU cable is not securely mated to the RIU serial port, or the cable is faulty.

**Or:** The HHT is faulty.

Determine cable or HHT fault source through substitution with spare components.

#### *Page 2 of 3 test results:*

A library file called "DIALOGUE.DLL" should be displayed. If not:

One of the critical embedded commands in the DEFAULT.CFG file has been corrupted. Re-load the DEFAULT.CFG file from either your backup copy or from the original Synapse model installation disk. To install from the model installation disk, use the command: COPY A:\DEFAULT.CFG C:\MBUILDER\USER\MODELS

#### *Page 3 of 3 test results:*

A configuration file called "SYN <OP>WS.INI" should be displayed. (OP = 4 for SYN-WS-04 or 8 for SYN-WS-08). If not: One of the critical embedded commands in the DEFAULT.CFG file has been corrupted. Re-load the DEFAULT.CFG file from either your backup copy or from the original Synapse model installation disk. To install from the model installation disk, use the command: COPY A:\DEFAULT.CFG C:\MBUILDER\USER\MODELS

**B. Problem:**

Operator HHT initializes with blank display when system starts.

***Suggestion:***

Follow the suggestions in Chapter 14C, item A to correct problems.

**C. Problem:**

Operator HHT initializes and functions correctly, then subsequently goes blank during operation.

***Suggestion:***

***Step 1)*** Ensure that the main node is running. Correct main node problems as needed: restore power or restart system.

***Step 2)*** Perform the TDM Card and RIU check, Chapter 10B. If the results are negative, follow the procedures in Chapter 14B to correct problems.

***Step 3)*** Determine whether the HHT or HHT-to-RIU cable is faulty through substitution with spare components.

## 14D. Operator Station Troubleshooting

If an operator station cannot communicate with other local or remote operators, make sure that the HHT, RIUs and TDM ring are functioning properly - see Chapter 14C for guidance. If the procedures in Chapter 14C are successfully completed and communication problems persist, follow the procedures in this chapter to correct problems.

Note that the term “local” refers to an operator sharing the same Synapse node, and “remote” refers to operators connected to other, networked Synapse nodes.

### A. Problem:

Operator can't communicate with any local/remote operators.

#### *Suggestion:*

*Step 1)* Inspect the HHT display to ensure that it is correctly configured for Transmit / Receive status on the desired nets. This is accomplished either at startup through the initialization file or by the user from the HHT keypad. See Chapter 8 for the HHT initialization procedure. See Chapter 12 for an overview of operator HHT operation.

*Step 2)* Perform the TDM Card and RIU check, Chapter 10B. If the results are negative, follow the procedures in Chapter 14B to correct problems.

*Step 3)* Inspect the Error page (from the Main Menu: speedkey E) for error messages. Correct any errors - see Chapter 14A for guidance.

*Step 4)* Test the audio peripherals (mics, speakers, headsets, PTTs and cables) using the offline operator station test procedure in Chapter 13, Item E. Isolate faults through substitution with spare components.

### B. Problem:

The operator can't communicate with any local operators, but can communicate with other remote operators.

#### *Suggestion:*

*Step 1)* Inspect the HHT display to ensure that it is correctly configured for Transmit / Receive status on the desired nets. This is accomplished either at startup through the initialization file or by the user from the HHT keypad. See Chapter 8 for the HHT initialization procedure. See Chapter 12 for an overview of Controller HHT operation.

*Step 2)* Perform the TDM Card and RIU check, Chapter 10B. If the results are negative, follow the procedures in Chapter 14B to correct problems.

*Step 3)* Inspect the Error page (speedkey E from the Main Menu) for error messages. Correct any errors - see Chapter 14A for guidance.

**C. Problem:**

Operator can communicate with all local operators, but can't communicate with any remote operators.

***Suggestion:***

This indicates a DIS network problem. Refer to Chapter 14F for guidance.

**D. Problem:**

The volume of operator voice transmissions is excessively quiet at all receive stations (including other operators and live RT nets).

***Suggestion:***

The internal jumpers for RIU input mic gain are not configured correctly. Re-configure the jumpers following the procedure in Chapter 5A.

**14E. Base RT Troubleshooting**

For solutions to problems relating to communications with live RTs, refer to the ASTi Synapse Radio-Data Network Bridge Operator Manual, Chapter 14.

## 14F. DIS Network Troubleshooting

**HINT:** Model Builder includes some powerful network monitoring utilities that run in realtime. You should become familiar with these utilities: The DIS Status page, a utility that shows local node DIS configuration, including: Local IP address, Broadcast IP Address, UDP Ports, Subnet Mask, Site ID and Host ID. This page allows the user to check the node configuration presets, loaded from the DEFAULT.CFG file. See Chapter 10F for details.

The DIS Status page also features a series of counters that indicate good and bad transmit and receive packet counts at the IP and UDP level for DIS Receive, Transmit and Signal PDUs. These counters provide a utility that is useful for diagnosing network-level problems. These are described in Chapter 10F.

Also under the DIS Network menu is a series of lists (Freq of Xmitters, Local Xmitters, Transmitters, Receivers and Local Receivers) that provide the user with a network-wide view that is invaluable during exercise coordination or troubleshooting. These lists show local and network Transmit and Receive PDUs for a selected DIS exercise ID. These are described in Chapter 13, item C.

### A. Problem:

Local operators can communicate with each other, but can't receive or transmit to remote DIS operators. Remote sites cannot communicate with the local operators at your site.

#### **Suggestion:**

**Step 1)** Ensure that a link with the DIS network has been established. Inspect the DIS Status page (from the Main Menu: speedkey D - speedkey S), there should be incrementing counts in the TX Byte Count and TX Good Count fields. If these fields are not incrementing, and the TX Errors field is incrementing, the Synapse DIS ethernet interface is not linked to the network. Resolve network link problems and re-try communications with remote sites. If problems persist:

**Step 2)** Ensure that your Synapse node has been configured with the correct DIS Exercise ID. Inspect the Frequency of Xmitters page (from the Main Menu: speedkey D - speedkey F) for the desired exercise to ensure that local (yellow) and remote (white) DIS transmitters are present in the list. See Chapter 10F, item C for guidance. If the local transmitters are not in the desired exercise list, you need to revise the INI file to include the correct DIS Exercise ID. Refer to Chapter 8A, item F for guidance. If problems persist:

**Step 3)** Ensure that your Synapse node has been configured with the correct DIS receive and transmit port numbers. Inspect the DIS Status page (from the Main Menu: speedkey D - speedkey S) to see if the system has been configured with the correct DIS UDP port numbers. If the incorrect port numbers have been assigned, make corrections to the DEFAULT.CFG file. See Chapter 7A, items E and F for guidance.

**NOTE:** If there is a DIS Port Number mismatch between your site and all of the other remote sites, you will notice the following indications on the DIS Status page during active DIS communications:

```
TX Byte Count, TX Good Count, DIS tx pdus, DIS SIG pdus tx: All Incrementing
RX Byte Count = Incrementing
RX Good = Incrementing
DIS rx pdus and DIS SIG pdus rx = Not Incrementing
```

# APPENDIX A: RIU v4.1 TECHNICAL GUIDE

## A. General Information

1. Special configuration of the Remote Interface Unit (RIU) used with Synapse Workstation:
  - a. Operator RIU: ASTi PN SYN-RIU-OP. Interface module for operators. Marked “Operator RIU”. Unique internal jumper settings are shown here in section D1. Another special configuration of the RIU is used with the Synapse RT Bridge. Radio RIU: ASTi PN SYN-RIU-RT. Interface module for radio transceivers. Marked “Radio RIU”. This configuration **IS NOT FOR USE** with Synapse Workstation.
2. A packaged RIU weighs 1.5 lbs. The power supply included with the RIU weighs 0.5 lbs.
3. 19”, 1U high rackmount kits are available. Each kit will hold 3 RIUs.

### RIU Front Panel Face

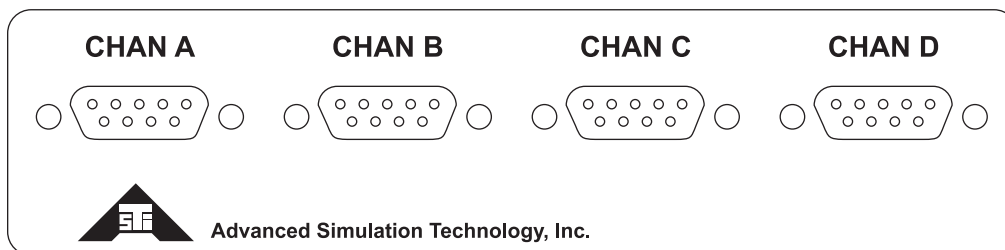

### RIU Rear Panel Face

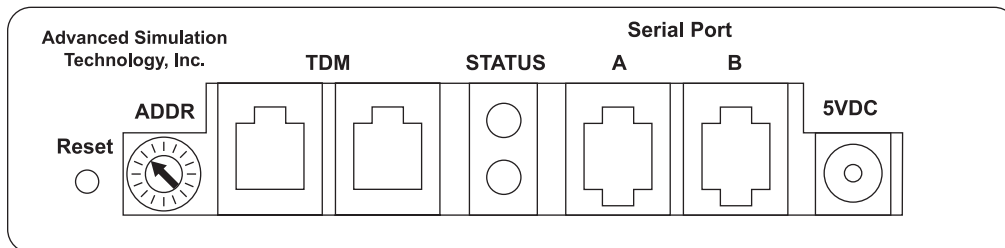

### RIU Dimensions

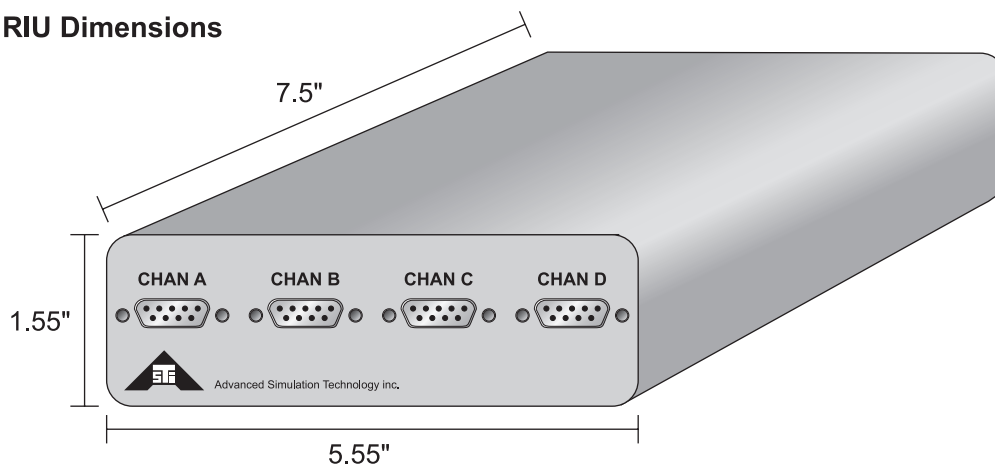

## B. Power Supply

1. Each RIU is supplied with an external +5 VDC regulated power supply. These power supplies are rated for 50/60Hz, 100-240Vac, and will supply a maximum of 2.5A.
2. The RIU includes an over-current protection device (1.1A trip point) that automatically resets itself.

## C. Connector Information

1. Power Supply: 2.1mm socket, center positive
2. Serial connections A & B: RJ-12 jacks

1 = TX+	4 = RX-
2 = TX-	5 = +5 VDC
3 = RX+	6 = Ground

3. TDM Link In/Out: RJ-45 jacks

1 = RX+	5 = SYN+	Interconnect using standard Category 5 unshielded twisted pair straight-through cables. (EIA/TIA 568A wiring standard)
2 = RX-	6 = TX-	
3 = TX+	7 = SCK+	
4 = SYN-	8 = SCK-	

4. Channels A, B, C & D: 9-pin, female, subminiature 'D' connector

1 = Digital Out +	6 = Digital Out-
2 = Audio Out, Hi	7 = Audio Out, Lo
3 = Digital In+	8 = Digital In- (I/O GND)
4 = Audio In, Hi	9 = Audio In, Lo
5 = Chassis Ground	

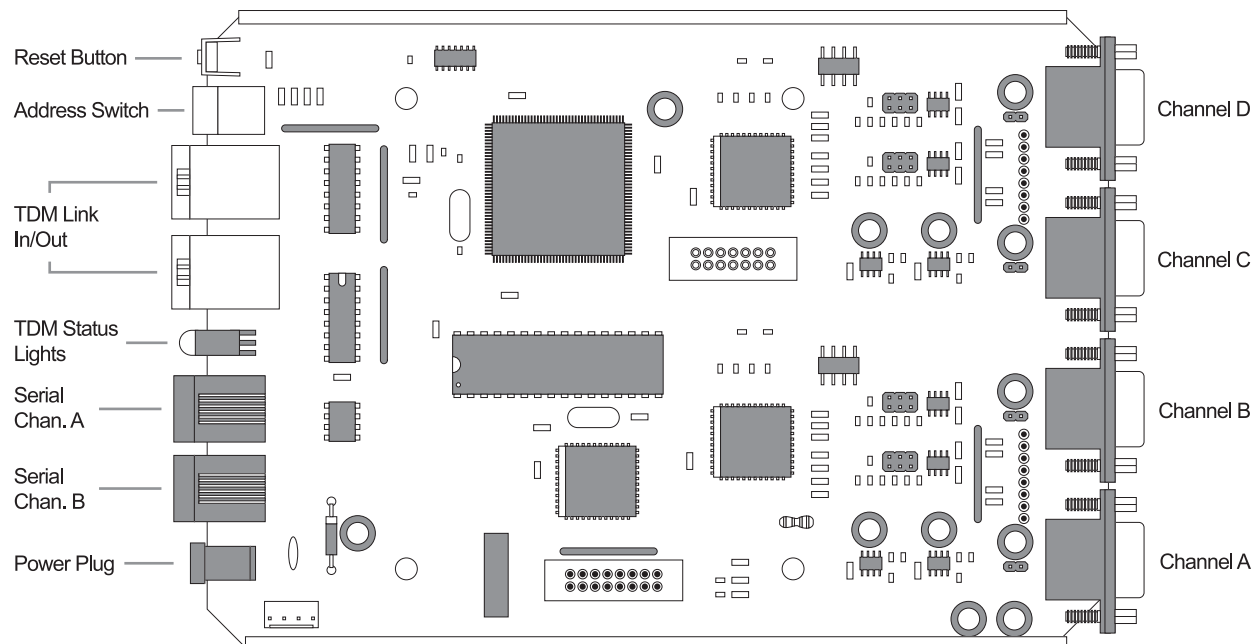

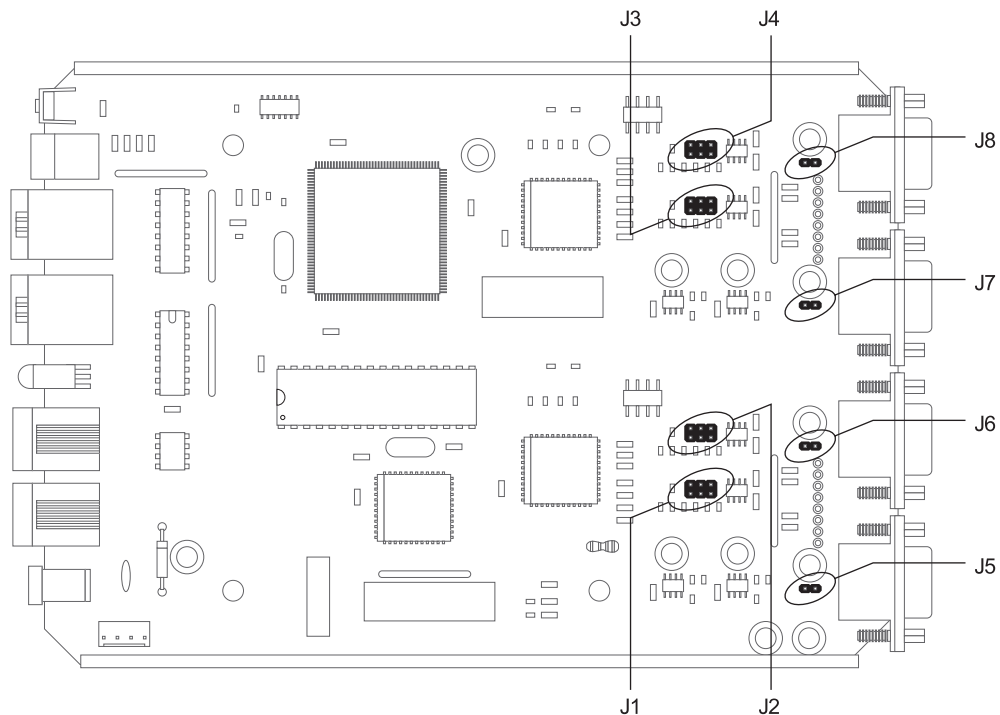

**Warning:** Take ESD precautions when handling the RIU board, EEPROM, or jumpers. When changing jumpers, first touch chassis ground, and then reposition the jumper.

#### D. Internal Jumper Settings

DESCRIPTION	RIU JUMPER SETTING	"Operator RIU" (SYN-WS-04 / -08)
Input Gain, Channel A	J1	40 dB
Input Gain, Channel B	J2	40 dB
Input Gain, Channel C	J3	40 dB
Input Gain, Channel D	J4	40 dB
Output Coupling, Channel A	J5	OPEN
Output Coupling, Channel B	J6	OPEN
Output Coupling, Channel C	J7	OPEN
Output Coupling, Channel D	J8	OPEN

Jumper guide for J1 through J4:

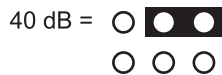

## **APPENDIX B: COLD START**

Complete disk preparation and software installation procedures vary, depending on the hardware platform used. For example, the miniDACS cold start procedure is completely different than that of the industrial, 2U DACS. Visit our website ([www.asti-usa.com](http://www.asti-usa.com)) to download platform-specific instructions.

---

## APPENDIX C: SAFETY and HANDLING

### A. Safety Precautions

This section must be read completely and understood before using the Digital Audio Communication System. If you are unsure of any information presented please contact ASTi. Methods of contact are listed at the end of this chapter.

The following safety precautions must be observed when performing any operation and maintenance tasks associated with the ASTi Digital Audio Communication System (DACS). These safety precautions are necessary to prevent injury to personnel and damage to equipment.

**\*\* WARNING \*\***

*Potentially fatal voltages are present in the Digital Audio Communication System. Before removing, handling, or replacing any DACS component, ensure that ALL electrical supplies have been turned off and electrical power cords disconnected from the Digital Audio Communication System.*

The following disclaimer is provided regarding use of the DACS. The disclaimer applies to all parties using the DACS in any situation or configuration. This disclaimer should be read and understood completely before using the Digital Audio Communication System.

**\*\* DISCLAIMER \*\***

*The DACS is a sound production device. The user, by the act of installing and using the DACS and any associated equipment such as external amplifiers, headsets, speakers, etc., warrants and represents that he/she is aware that excessive audio levels can cause permanent hearing impairment and that he/she assumes full responsibility for configuring all equipment including hardware and software to achieve safe operating sound pressure levels under all conditions.*

### B. Equipment Handling

All Digital Audio Communication System Circuit Boards and Modules are sensitive to electrostatic discharge (ESD). To avoid damage to DACS equipment, proper ESD procedures should be followed when handling all Digital Audio Communication System equipment. If it is necessary to remove and/or replace a circuit board or module, follow the procedures listed in Chapter 5, Test and Maintenance.

Ensure that all work is performed at a properly grounded ESD work station. In addition, all personnel handling DACS equipment should be properly grounded.

When transporting or shipping individual modules, equipment should be fully enclosed in an anti-static bag.

ASTi is not responsible for equipment damage due to improper handling.

## **APPENDIX D: WARRANTY and CUSTOMER SUPPORT**

### **A. Warranty**

ASTi provides a one year limited warranty on all ASTi equipment covering all parts and labor.

In the case of equipment upgrades, warranty applies to original date of shipment of individual components.

Other commercial equipment purchased or provided such as monitors, amplifiers, speakers, fiber optic links, etc. are also covered under the one year warranty unless otherwise stated.

The warranty does not cover improper equipment handling or improperly packaged returns.

Extended warranties are available. Contact ASTi for details.

### **B. Returns**

When returning damaged or broken equipment please contact ASTi for proper RMA# and return instructions. Equipment will not be received without proper return authorization.

Items out of warranty will require a purchase order to cover repair. If you are unsure if a particular item is covered under warranty, contact ASTi for assistance. At a minimum please have part number and serial number of equipment available.

Note that in many cases items returned will take some time to repair. If downtime is a concern, spares should be purchased to cover this possibility.

### **C. Customer Support**

Customer support is a major part of the ASTi digital communications solution. If you have any questions about our product, how it can be used for your application, or suggestions for future enhancements, you can contact ASTi in the following ways:

- 1. By E-mail.** Send an email any time to us at [info@asti-usa.com](mailto:info@asti-usa.com).
- 2. By Web.** You can reach us through the World Wide Web at [www.asti-usa.com](http://www.asti-usa.com).
- 3. By Fax.** Include your name, company, fax number, phone number where you can be reached, and your specific question. The fax number for ASTi is (703) 471-2108
- 4. By Phone.** Call the technical support line 9:00am to 5:00pm (Eastern) weekdays with your question. Someone will be happy to assist you. The number is (703) 471-2104.
- 5. By Mail.** Include your name, company, fax number, phone number where you can be reached, and your particular question. Mail to the following address:

ASTi  
500 A Huntmar Park Drive  
Herndon, VA 20170  
U.S.A.

## APPENDIX E: RMA PROCEDURE

If it becomes necessary to return equipment to ASTi for repair, please observe the following instructions:

- A.** Request an RMA number using the form on our website. The receiving department at ASTi will not receive a repair without an RMA number.
- B.** When packaging the equipment in question, make sure it is well protected. ALWAYS DOUBLE BOX the DACS with at least three inches of packaging material between the inner and outer cartons at the closest point. The inner container should employ some semi-rigid, contour-fitting foam, while the exterior container should use a more pliant, shock-absorbing material such as styrofoam peanuts. DACS, RIUs, DDIs and individual cards or modules should be properly enclosed in antistatic bags to prevent possible ESD damage. DO NOT ship monitors unless they are the item to be evaluated. Failure to properly package equipment could void warranty.
- C.** Do not include the accessory pieces, such as power cords, software and mounting brackets. Only return items that do not work.
- D.** The shipping label must include the RMA number.
- E.** Include a description of the problem including the serial number for the unit in question. Include point of contact information including name, telephone number and equipment return address. Failure to include a point of contact at your company could delay return of equipment.
- F.** Evaluation of equipment is performed free of charge. No work will be done without prior customer approval.
- G.** Note that if equipment is not under warranty, a purchase order will be required to cover any repairs. ASTi will provide a quote for all non-warranty items.
- H.** Equipment will be shipped back via Federal Express, unless otherwise directed. If it is a non-warranty repair, shipping charges will be billed.
- I.** If equipment is not received by ASTi within thirty (30) days of the RMA number issuing date, the request data and number issued will be closed and designated as unused.
- J.** Any items received from customers without RMA numbers or appropriate contact information included with shipment will not be tested. After sixty (60) days, ASTi reserves the right to scrap all hardware received in this condition.
- K.** International customers must include the correct product value on all shipping documents. Contact ASTi for proper harmonized tariff codes. The customer is responsible for all duties, taxes and fees incurred in shipment of the equipment.

## **APPENDIX F: FURTHER READING**

For information about ASTi's Synapse Radio Transceiver to Data Network Bridge, see: ASTi Synapse Radio-Data Network Bridge Operator Manual (DOC-01-SYN-OM-1).

For detailed operational information about the RTs see: 1. US ARMY, Operator's Manual, SINC-GARS Ground Combat Net Radio. RT-1523C/D (SIP) and RT-1523E (ASIP) Versions.